

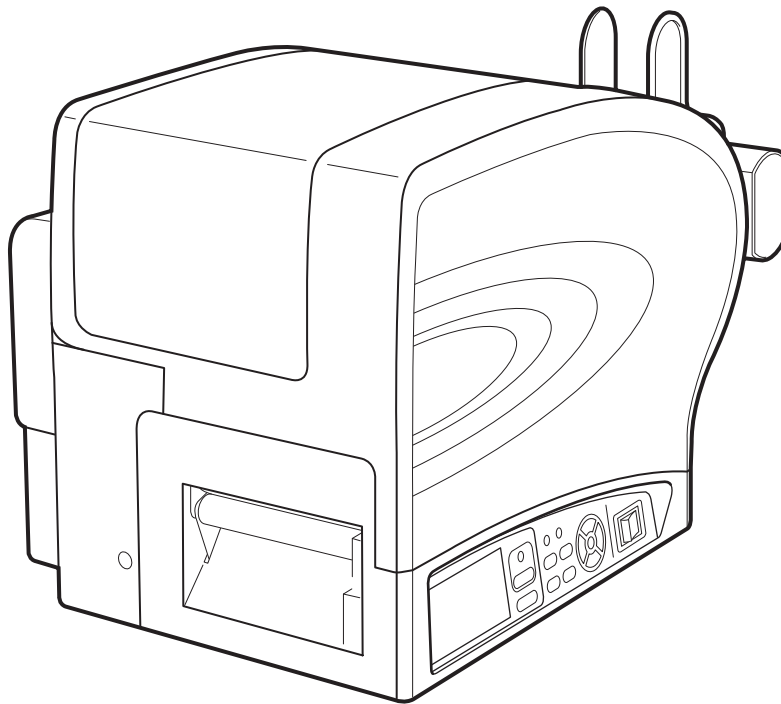

Operator Manual

For printer model:

TG3 Series



Read this Operator Manual before using this product.
Keep this document available for future reference.

NOTE:

The printer complies with the requirements in Part 15 of FCC Rules for a Class B Computing Device. Operating the printer in a residential area may cause unacceptable interference to radio and TV reception. If the interference is unacceptable, you can reposition the equipment, which may improve reception.

Be sure to ask your SATO representatives about our maintenance contracts to ensure peace of mind during your usage of SATO products.

Please refer to the back cover for SATO Group Member Company closest to your location. You may also visit our home page at www.satoworldwide.com for further updated details.

Copyrights

The contents of this document are proprietary information of SATO Corporation and/or its subsidiaries in Japan, the U.S and other countries. No part of this document may be reproduced, copied, translated or incorporated in any other material in any form or by any means, whether manual, graphic, electronic, mechanical or otherwise, without the prior written consent of SATO Corporation.

Limitation of Liability

SATO Corporation and/or its subsidiaries in Japan, the U.S and other countries make no representations or warranties of any kind regarding this material, including, but not limited to, implied warranties of merchantability and fitness for a particular purpose. SATO Corporation shall not be held responsible for errors contained herein or any omissions from this material or for any damages, whether direct, indirect, incidental or consequential, in connection with the furnishing, distribution, performance or use of this material.

SATO Corporation reserves the right to make changes and/or improvements in this product and document without notice at any time.

Trademarks

SATO is a registered trademark of SATO Corporation and/or its subsidiaries in Japan, the U.S and other countries.

Version: GBS-TG3-01rA-25-01-100M

© Copyright 2010 SATO Corporation.

All rights reserved.



Safety Precautions

Please read the following information carefully before installing and using the printer.

Pictographic Symbols

This instruction manual and the printer labels use a variety of pictographic symbols to facilitate safe and correct use of the printer and to prevent injury to others and property damage. The symbols and meanings for them are given below. Be sure to understand these symbols well before reading the main text.

Example Pictographs

 Warning	Ignoring the instructions marked by this symbol and erroneously operating the printer could result in death or serious injury.
 Caution	Ignoring the instructions marked by this symbol and erroneously operating the printer could result in injury or property damage.





The  pictograph means "Caution is required." A specific warning symbol is contained inside this pictograph (The symbol at left is for electric shock).







The  pictograph means "Should not be done." What is specifically prohibited is contained in or near the pictograph (The symbol at left means "Disassembly prohibited").

















The  pictograph means "Must be done." What is specifically to be done is contained in the pictograph (The symbol at left means "Unplug the power cord from the outlet").

 Warning		
<p>Do not set on an unstable area</p> <ul style="list-style-type: none"> Do not set on an unstable area, such as a wobbly table or slanted area or an area subject to strong vibration. If the printer falls off or topples over, it could injure someone. <p>Do not place containers full of water or other liquid on the printer</p> <ul style="list-style-type: none"> Do not place flower vases, cups, or other containers holding liquids, such as water or chemicals, or small metal objects near the printer. If they are spilled and get inside the printer, immediately turn off the power switch, unplug the power cord from the outlet, and contact your SATO reseller or technical support center. Using the printer in this condition could cause a fire or electric shock. <p>Do not put objects inside the printer</p> <ul style="list-style-type: none"> Do not insert or drop in metal or burnable objects inside the printer's openings (cable outlets, etc.). If foreign objects do get inside the printer, immediately turn off the power switch, unplug the power cord from the outlet, and contact your SATO reseller or technical support center. Using the printer in this condition could cause a fire or electric shock. 	<p>Do not use other than the specified voltage</p> <ul style="list-style-type: none"> Do not use other than the specified voltage. Doing so could result in fire or electric shock. <p>Always ground the connections</p> <ul style="list-style-type: none"> Always connect the printer's ground wire to a ground. Not grounding the ground wire could result in electric shock. <p>Handling of the power cord</p> <ul style="list-style-type: none"> Do not damage, break, or modify the power cord. Also, do not place heavy objects on the power cord, heat it, or pull it because doing so could damage the power cord and cause a fire or electric shock. If the power cord becomes damaged (core is exposed, wires broken, etc.), contact your SATO reseller or technical support center. Using the power cord in this condition could cause a fire or electric shock. Do not modify, excessively bend, twist, or pull the power cord. Using the power cord in such a condition could cause a fire or electric shock. 	<p>When the printer has been dropped or broken</p> <ul style="list-style-type: none"> If the printer is dropped or broken, immediately turn off the power switch, unplug the power cord from the outlet, and contact your SATO reseller or technical support center. Using the printer in this condition could cause a fire or electric shock. <p>Do not use the printer when something is abnormal about it</p> <ul style="list-style-type: none"> Continuing to use the printer in the event something is abnormal about it, such as smoke or unusual smells coming from it, could result in fire or electric shock. Immediately turn off the power switch, unplug the power cord from the outlet, and contact your SATO reseller or technical support center for repairs. It is dangerous for the customer to try to repair it, so absolutely do not attempt repairs on your own. <p>Do not disassemble the printer</p> <ul style="list-style-type: none"> Do not disassemble or modify the printer. Doing so could result in fire or electric shock. Contact your SATO reseller or technical support center to conduct internal inspections, adjustments, and repairs.

Safety Precautions

 Warning		
<p>Regarding the cutter</p>  <ul style="list-style-type: none"> Do not touch the cutter with your hands or do not put something into the cutter. Doing so could result in an injury. 	<p>Using the head cleaning fluid</p>   <ul style="list-style-type: none"> Use of flame or heat around the head cleaning fluid is prohibited. Absolutely do not heat it or subject it to flames. Keep the fluid out of reach of children to prevent them from accidentally drinking it. If the fluid is drunk, immediately consult with a physician. 	

 Caution		
<p>Do not place in areas with high humidity</p>  <ul style="list-style-type: none"> Do not place the printer in areas with high humidity or where condensation forms. If condensation forms, immediately turn off the power switch and do not use the printer until it dries. Using the printer while condensation is on it could result in electric shock. <p>Carrying the Printer</p>    <ul style="list-style-type: none"> When moving the printer, always unplug the power cord from the outlet and check to make sure all external wires are disconnected before moving it. Moving the printer with the wires still connected could damage the cords or connecting wires and result in a fire or electrical shock. Do not carry the printer with paper loaded in it. The paper could fall out and cause an injury. When setting the printer on the floor or a stand, make sure not to get your fingers or hands pinched under the printer feet. 	<p>Power supply</p>  <ul style="list-style-type: none"> Do not operate the power switch or plug in/unplug the power cord with wet hands. Doing so could result in electric shock. <p>Power cord</p>    <ul style="list-style-type: none"> Keep the power cord away from hot devices. Getting the power cord close to hot devices could cause the cord's covering to melt and cause a fire or electrical shock. When unplugging the power cord from the outlet, be sure to hold it by the plug. Pulling it by the cord could expose or break the core wires and cause a fire or electric shock. The power cord set that comes with the printer is especially made for this printer. Do not use it with any other electrical devices. <p>Top cover</p>  <ul style="list-style-type: none"> Be careful not to get your fingers pinched when opening or closing the top cover. Also be careful the top cover does not slip off and drop. 	<p>Print head</p>   <ul style="list-style-type: none"> The print head is hot after printing. Be careful not to get burned when replacing paper or cleaning immediately after printing. Touching the edge of the print head immediately after printing could result in injury. Use caution when replacing the label or cleaning the print head. You should not replace the print head without having received the proper training. <p>Loading paper</p>  <ul style="list-style-type: none"> When loading roll paper, be careful not to get your fingers pinched between the paper roll and the supply unit. <p>When not using the printer for a long time</p>  <ul style="list-style-type: none"> When not using the printer for a long time, unplug the power cord from the outlet to maintain safety. <p>During maintenance and cleaning</p>  <ul style="list-style-type: none"> When maintaining and cleaning the printer, unplug the power cord from the outlet to maintain safety.

Precautions for Installation and Handling

Printer operation can be affected by the printer environment. Refer to the following instructions for installation and handling of TG3 Series printer.

Select a Safe Location

Place the printer on a surface that is flat and level.

If the surface is not flat and level, this may result in poor print quality. This may also cause malfunction and shorten the life span of the printer.

Do not place the printer on a location that produces vibration.

Giving serious vibration or shock to the printer may cause malfunction and shorten the life span of the printer.

Keep the printer out of high temperature and humidity.

Avoid locations subject to extreme or rapid changes in temperature or humidity.

Do not place the printer in a location subject to water or oil.

Do not place the printer in a location where it will be splashed with water or oil. Water or oil entering inside the printer may cause a fire, electric shock, or malfunction.

Avoid dust.

Dust build up may result in poor print quality.

Keep out of direct sunlight.

This printer has a built-in optical sensor. Exposure to direct sunlight will make the sensor less responsive and may cause the label to be sensed incorrectly. Close the top cover when printing.

Power Supply

This printer requires an AC power supply.

Be sure to connect the printer to an AC power supply.

Connect the power cord to a grounded power outlet.

Make sure that the printer is plugged into a grounded power outlet.

Provide a stable source of electricity to the printer.

When using the printer, do not share its power outlet with other electrical devices that could result in power fluctuations and performance issues with your printer.

TABLE OF CONTENTS

Introduction	1 - 1
1.1 Features of the Printer.....	1 - 2
1.2 Unpacking	1 - 2
1.2.1 Included Accessories	1 - 2
1.3 Parts Identification.....	1 - 3
Installation	2 - 1
2.1 Site Location.....	2 - 2
2.2 Media Selection.....	2 - 2
2.3 Loading Media.....	2 - 3
2.4 Media Type selection	2 - 6
2.5 Cutter Sensor Adjustment	2 - 7
2.6 Loading the Carbon Ribbon	2 - 8
2.7 Remove the Carbon Ribbon.....	2 - 10
2.8 Basic Connections.....	2 - 11
2.8.1 Install and Connecting the Interface board	2 - 11
2.8.2 To Configure the Connected Interface.....	2 - 12
2.8.3 Connecting the Power Cable	2 - 13
2.8.4 Turning On the Power.....	2 - 14
2.8.5 Turning Off the Power	2 - 14
2.9 LCD Power Saving Mode	2 - 15
2.9.1 Turning off the LCD Backlight.....	2 - 15
2.9.2 Turning on the LCD Backlight.....	2 - 15
Operation and Configuration	3 - 1
3.1 Operator Panel.....	3 - 2
3.2 Operating Modes.....	3 - 5
3.3 ONLINE And OFFLINE Modes.....	3 - 8
3.3.1 Online Mode	3 - 8
3.3.2 Offline Mode	3 - 8
3.3.3 To Adjust the Screen Contrast.....	3 - 9
3.4 Adjustment Screen	3 - 10
3.5 Cancel Print Job Mode	3 - 11
3.6 User Mode.....	3 - 12
3.7 Interface Mode	3 - 14
3.7.1 Overview of Interface Mode Configurations	3 - 14
3.7.2 Enabling Interface Card Configuration.....	3 - 16
3.8 SEMBL Mode	3 - 24
3.9 Advanced Mode	3 - 25
3.10 HEX Dump Mode	3 - 30
3.11 RFID USER Mode	3 - 31
3.12 Test Print Mode	3 - 35
3.13 Default Setting Mode.....	3 - 38
3.13.1 Table of Default Settings	3 - 39
3.14 Maintenance Mode.....	3 - 41

3.15 Service Mode	3 - 42
3.15.1 Overview of Sensor Level adjustment in Service Mode.....	3 - 42
3.15.2 Pitch Offset adjustment in Service Mode	3 - 44
3.15.3 Cut Offset adjustment in Service Mode	3 - 45
3.15.4 Backfeed Offset adjustment in Service Mode	3 - 46
3.15.5 Loading Offset adjustment in Service Mode	3 - 47
3.15.6 Overview of Setting menu in Service Mode	3 - 48
3.16 RFID Mode	3 - 50
3.17 Download Mode	3 - 52
Cleaning and Maintenance	4 - 1
4.1 Cleaning The Print Head, Platen and Rollers.....	4 - 2
4.2 How To Clean The Printer (Cleaning Kit)	4 - 2
4.3 How To Clean The Printer (Cleaning Sheet).....	4 - 3
4.4 Adjusting Print Quality	4 - 4
4.4.1 Adjusting Print Darkness	4 - 4
4.4.2 Adjusting Print Speed	4 - 4
Troubleshooting	5 - 1
5.1 Error signal Troubleshooting	5 - 2
5.1.1 Error Message	5 - 2
5.1.2 More information about Command Error	5 - 6
5.1.3 Warning Message	5 - 7
5.2 Troubleshooting Table.....	5 - 8
5.3 Interface Troubleshooting.....	5 - 10
5.4 Test Print Troubleshooting	5 - 11
5.4.1 Hex Dump	5 - 11
5.4.2 Test label printing	5 - 11
Basic Specifications	6 - 1
6.1 Printer Basic Specifications.....	6 - 1
6.2 Optional Accessories Specifications	6 - 8
Interface Specifications	7 - 1
7.1 Interface Types.....	7 - 1
7.2 RS232C High Speed Serial Interface.....	7 - 2
7.2.1 RS-232C Serial Interface Card DIP SWITCH Settings.....	7 - 2
7.2.2 Basic Specifications	7 - 3
7.2.3 Ready/Busy	7 - 4
7.2.4 X-ON/X-OFF	7 - 5
7.3 IEEE 1284 Parallel Interface	7 - 6
7.3.1 Basic Specifications	7 - 6
7.3.2 Pin Assignments	7 - 7
7.3.3 Input and Output Signals	7 - 8
7.4 Universal Serial Bus (USB) Interface	7 - 9
7.4.1 Basic Specifications	7 - 9
7.4.2 Pin Assignments	7 - 9
7.5 Local Area Network (LAN) Ethernet.....	7 - 10
7.5.1 Basic Specifications	7 - 10
7.6 Wireless LAN Ethernet.....	7 - 12
7.6.1 Basic Specifications	7 - 12

Table of Contents

7.7 LAN and Wireless LAN Ethernet Specifications	7 - 15
7.7.1 Software Specifications	7 - 15
7.7.2 TCP/IP Specifications	7 - 15
7.7.3 LPD Specifications	7 - 15
7.7.4 FTP Specifications	7 - 15
7.7.5 TELNET Specifications	7 - 16
7.7.6 Setting/Displayed Items	7 - 17
7.7.7 Wireless LAN Setting	7 - 18
7.8 External Signal Interface (EXT)	7 - 18
7.8.1 Basic Specifications	7 - 19
7.8.2 Pin Assignments	7 - 19
Appendix	8 - 1
8.1 Optional Accessories - Stacker	8 - 2
8.1.1 Parts of Stacker Unit	8 - 2
8.1.2 To install the Stacker	8 - 3
8.2 Optional Accessories - Label Rewinder	8 - 4
8.2.1 To install the Label Rewinder	8 - 4
8.3 Optional Accessories - Keypad	8 - 4
8.4 Positions of Sensors and Options	8 - 5
8.5 Base Reference Point	8 - 6
8.6 Offset Position Adjustment	8 - 7
8.5.1 Adjustment of Print Position	8 - 7
8.5.2 Adjustment of Cut Position	8 - 7
8.5.3 Adjustment of Backfeed Distance	8 - 9
8.5.4 Adjustment of Media Feeding Position	8 - 10
8.6 Shifting Motion of Base Reference Point	8 - 11
8.7 Jump Hole	8 - 12
8.8 Tag Sorting Method	8 - 13
8.8.1 Batch Separator	8 - 13
8.8.2 Separator	8 - 14
8.9 Paper End	8 - 15
8.9.1 End Mark	8 - 15
8.9.2 Paper End Error Detection	8 - 16
8.10 Ribbon End	8 - 17
8.11 Ribbon Near End	8 - 17
8.12 Media Size Check	8 - 17
8.13 Perforated Line	8 - 18
8.14 Information on Media when using Cutter	8 - 19
8.14.1 Cutting of Labels	8 - 19
8.14.2 Cutting Media with Perforation	8 - 19
8.14.3 Cutter replacement	8 - 19
Sato Group of Companies	9 - 1
Sato Group of Companies	9 - 2

1

INTRODUCTION

Thank you for your investment in this SATO printer product.

This Operator Manual contains the basic information about the installation, setup, configuration, operation and maintenance of the printer.

A total of eight topics are covered herein, and they are organized as follows:

- Section 1: Introduction
- Section 2: Installation
- Section 3: Configuration and Operation
- Section 4: Cleaning and Maintenance
- Section 5: Troubleshooting
- Section 6: Basic Specifications
- Section 7: Interface Specifications
- Section 8: Appendix

It is recommended that you read carefully and become familiar with each section before installing and maintaining the printer. Refer to the **Table Of Contents** at the front of this manual to search for the relevant information needed. All page numbers in this manual consist of a section number followed by the page number within the stated section.

This section assists you in unpacking the printer from the shipping container. You will also be guided through a familiarization tour of the main parts and controls.

The following information is provided herein:

- Features of the printer
- Unpacking
- Parts Identification

1.1 FEATURES OF THE PRINTER

The SATO TG3 Series printers (Thermal Transfer or Direct Thermal) are complete, high-performance labeling systems designed specifically for printing tags and labels.

The key features of the TG3 Series are:

- High Printing Speed and Throughput (32-bit RISC CPU (100MHz), Up to 10 ips print speed)
- Large Internal Memory Size (8MB Flash-ROM)
- Plug-in Interface Cards (Parallel IEEE1284, LAN, Wireless LAN, USB or the high speed RS-232C interface can be selected)
- Thick Tags Supported (Up to 0.33mm thick)
- Print, Cut and Stack Operation
- Batch Separation Function
- Wide Range of Media Types Supported
- Large Media Roll Supported
- Large and Energy Efficient LCD Display
- Easy and More User-Friendly Operation
- HF and UHF RFID Support
- Coreless Ribbon Spindle
- Standalone Capability using SEMBL or SATO Keypad
- European and Asian Codepages

1.2 UNPACKING

When unpacking the printer, take note of the following:

1. The box should stay right-side up. Lift the printer out of the box carefully.
2. Remove all the packaging from the printer.
3. Remove the accessory items from their protective containers.
4. Set the printer on a solid, flat surface. Inspect the shipping container and printer for any sign of damage that may have occurred during shipping. Please note that SATO shall hold no liability of any damage of any kind sustained during shipping of the product.

Notes:

- If the printer has been stored in the cold, allow it to reach room temperature before turning it on.
- Please do not discard the original packaging box and cushioning material after installing the printer. They may be needed in future, if the printer needs to be shipped for repairs.

1.2.1 Included Accessories

After unpacking the printer, verify that you have the following materials:

User Documents
(Quick Guide, Warranty, etc)



Power plug*

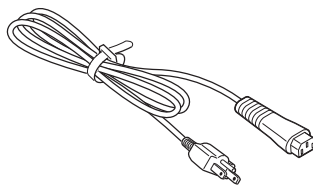

Bosses and securing screws

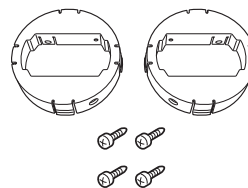

* The shape of the power plug may vary, depending on the location where it was purchased.

1.3 PARTS IDENTIFICATION

Front view



- ① **Main cover**
Open this cover to load the media and ribbon.
- ② **Power (I/O) switch**
Press this switch to turn the power on (I) or off (O).
- ③ **Keypad connection terminal**
Used to connect to the optional keypad.

- ④ **Media ejection slot**
Opening for media output.
- ⑤ **Operator panel**
It consists of ten contact buttons and three LED indicators. Please refer to **Section 3.1 Operator Panel**.

1.3 PARTS IDENTIFICATION (cont'd)

Back view

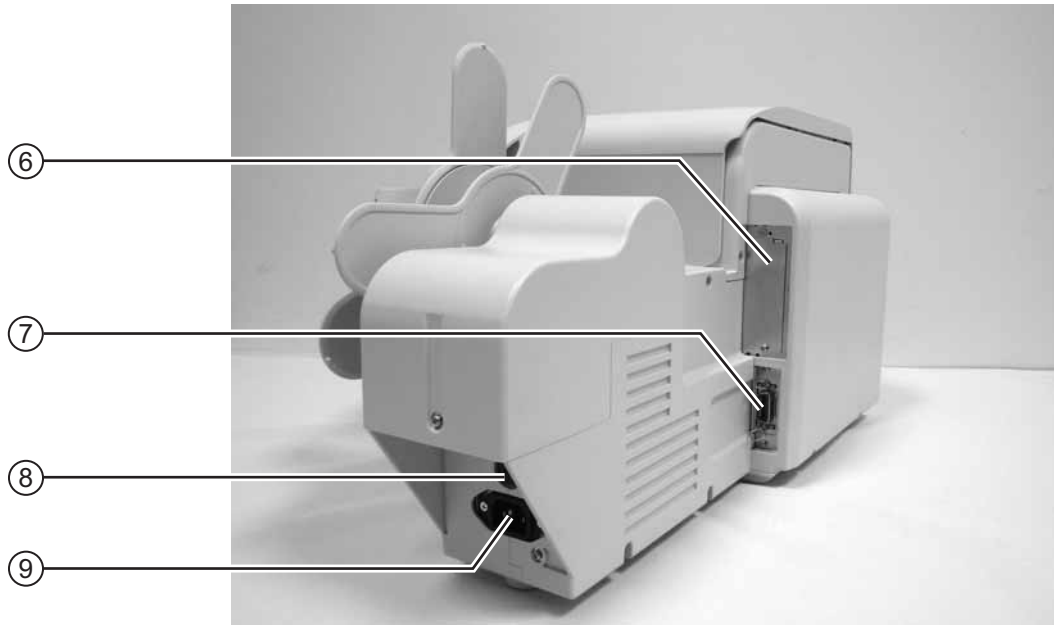

-
- ⑥ **Interface slot**
Optional interface slot for connection to a host PC. An option of RS-232C (High-speed) interface board, IEEE1284 interface board, LAN interface board, Wireless LAN interface board and USB interface board are available for connection.
 - ⑦ **External connector terminal (EXT)**
Interface connector for external signals. Connect the optional stacker or rewinder to this terminal.

- ⑧ **FUSE (T5AH 250V) holder**
Used to hold a fuse which protect the printer from unstable power supply surge. Use fuse with rating, T5AH 250V only.
- ⑨ **AC IN power terminal**
Supplies power to the printer by inserting the power cable.
Before connection, ensure that the AC voltage of your region is within the range of AC 100 to 240V, 50/60 Hz.

1.3 PARTS IDENTIFICATION (cont'd)

Internal view when Main cover is opened (Front view)

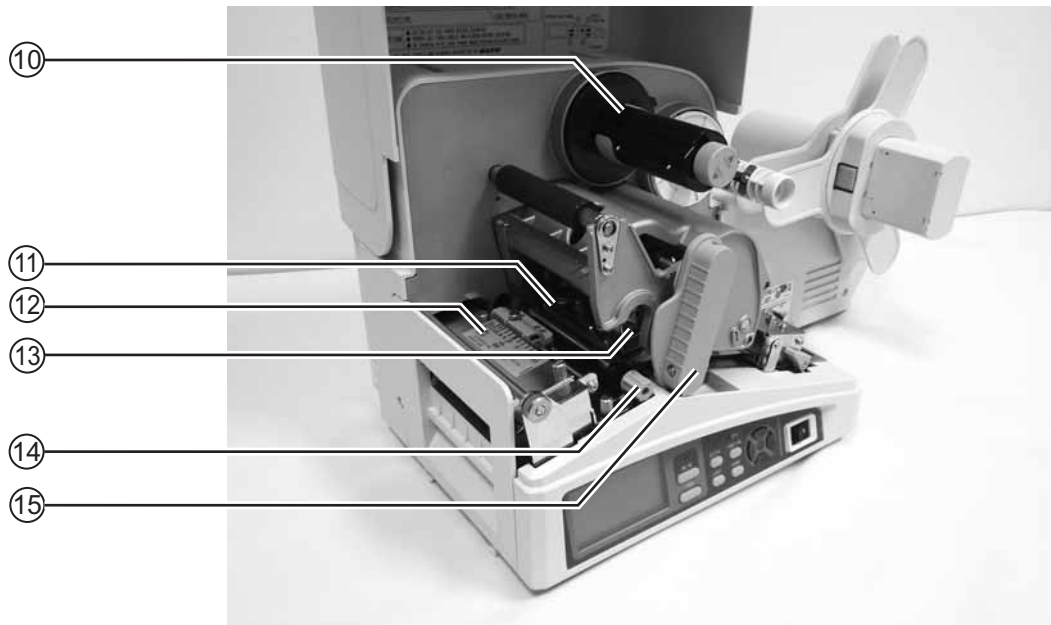

-
- | | |
|--|--|
| <p>⑩ Ribbon take-up spindle (coreless)
Used to wind up the used ribbon without using core.</p> <p>⑪ Print head assembly
This component is used to print on the media. Perform maintenance at regular intervals.</p> <p>⑫ Cutter assembly
This assembly consist of cutter as well as the cutter sensor assembly.</p> | <p>⑬ Head balance adjustment knob
To adjust print head balance to obtain consistent print out across media.</p> <p>⑭ Head Alignment adjustment knob
To adjust print head alignment to obtain consistent print out across media.</p> <p>⑮ Head lock lever
Used to open and close the print head.</p> |
|--|--|

1.3 PARTS IDENTIFICATION (cont'd)

Internal view when Main cover is opened (Back view)

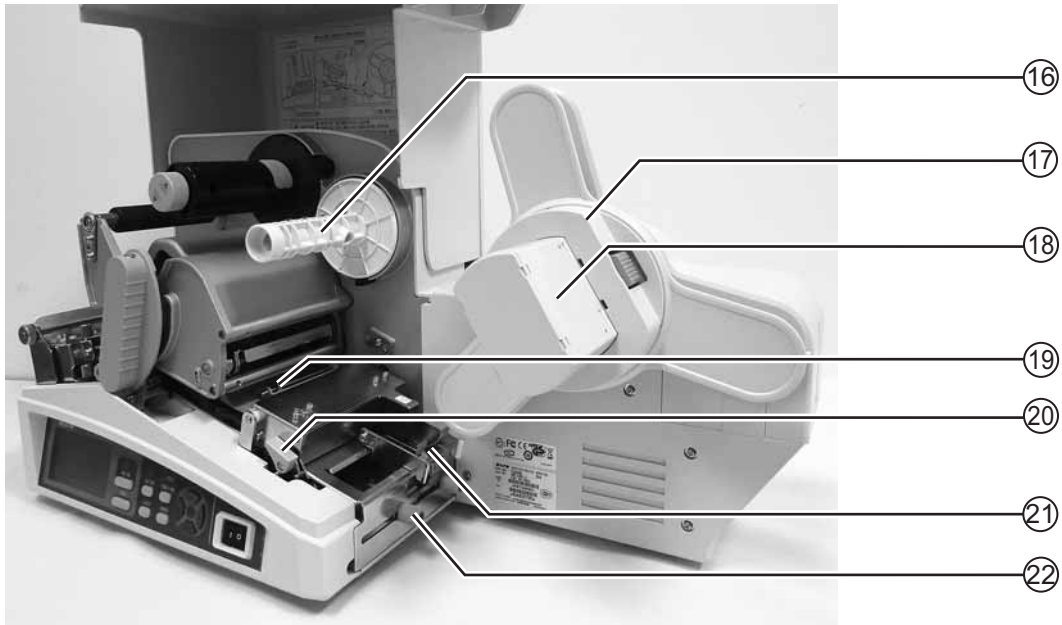

①⑥ **Ribbon supply spindle**

Used to load the ribbon.

①⑦ **Roll media guide**

Set to meet the size of the media used.

①⑧ **Roll media supply spindle**

Used to load the roll media, tag or label.

①⑨ **Pitch sensor guide**

This plate guides the media passing through the pitch sensor.

②⑦ **Lid Latch lever**

Press the purple Lid Latch lever to open the hinged Lid Latch.

②① **Media feed-in guide**

Feed in the media to the printer from this guide.

②② **Media guide knob**

Set the media guide to meet the size of the media used.

2

INSTALLATION

This section assists you in general printer set up and installing consumable media in the printer, as well as interface connection with host computer and other optional attachment units.

The following information is provided:

- 2.1 Site Location
- 2.2 Media Selection
- 2.3 Loading Media
- 2.4 Media Type selection
- 2.5 Cutter Sensor Adjustment
- 2.6 Loading the Carbon Ribbon
- 2.7 Remove the Carbon Ribbon
- 2.8 Basic Connections
- 2.9 LCD Power Saving Mode

2.1 SITE LOCATION

Consider the following when setting up the printer:

- Place the printer on a solid flat surface with adequate space. Make sure there is enough space above the printer to provide clearance for the top cover to swing open.
- If a Stacker unit is to be used with the printer, make sure there is adequate room for the unit.
- Place it away from hazardous materials or dusty environments.
- Place it within operational distance of the host computer, within interface cable specifications.

2.2 MEDIA SELECTION

The size and type of the labels or tags to be printed should have been taken into consideration before printer purchase. Ideally, the media width will be equal to, or just narrower than, the print head. Using media that does not cover the print head will allow the platen roller to tread on it and wear it out. The media edge will also wear a groove in the platen roller, which can affect print quality.

Note:

For optimal print performance and durability, **please use SATO-certified media and ribbon supplies on this printer.** Using supplies not tested and approved for use by SATO can result in unnecessary wear and damage to vital parts of the printer, and may void the warranty.

This printer can use six different types of media, the figures below identifies the media types and their specifications. The printer uses different sensors to detect the Center hole, Side hole, R-corner (Notch/Edge), I-Marks or Gap on the media in order to precisely position the print content.

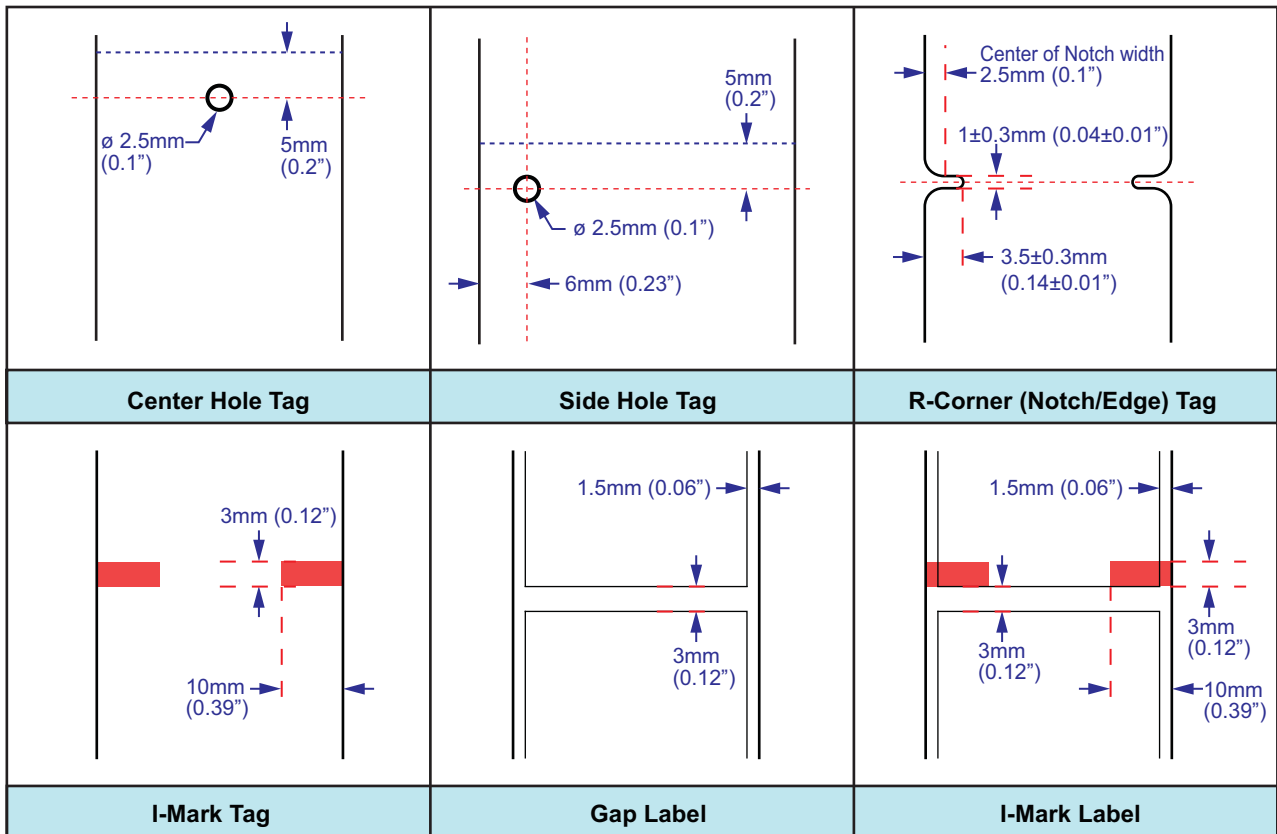

2.2 MEDIA SELECTION (cont'd)

This printer accepts two types of media core sizes, ϕ 75mm (2.95") and ϕ 100mm (4"). When using ϕ 100mm (4") core size media, the supplied bosses need to be installed to the printer.

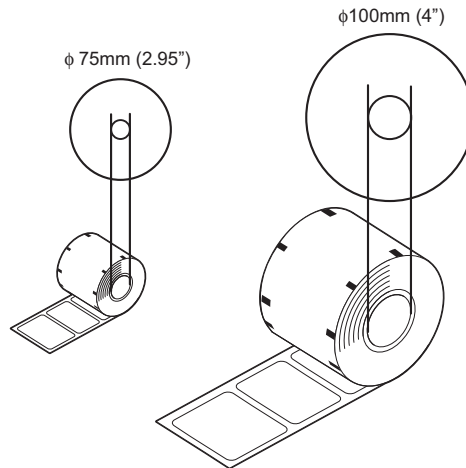

2.3 LOADING MEDIA

1. Lift up the **main cover**.

Note:

Make sure that the cover rests firmly so that it will not fall forward and injure your hands.



2. Remove the **roll media guide** by pressing the release tab with your thumb and index finger and pulling it out.

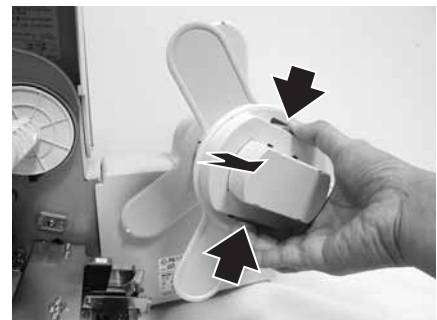

2.3 LOADING MEDIA (cont'd)

3. If the inner diameter of the roll is 100 mm (4”), attach the supplied **boss** at the **roll media supply spindle**. If the inner diameter of the roll is 75 mm (2.95”), proceed to Step 4.

Using the boss attachment positions given in the following table as a guide, attach the **boss** and then fasten it in place with the **screws** provided. Attached the screws on both opposite side of the boss.

Boss attachment position	Media width
Attachment hole 1, 2	Up to 40 mm (1.6”)
Attachment hole 2	Up to 50 mm (2”)
Attachment hole 3	50 mm (2”) to 80 mm (3.1”)

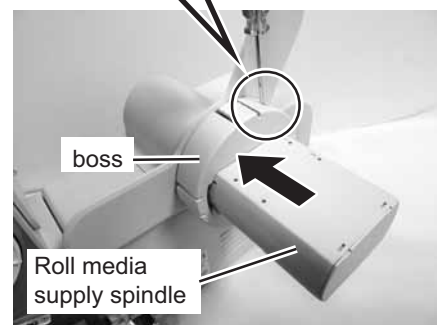
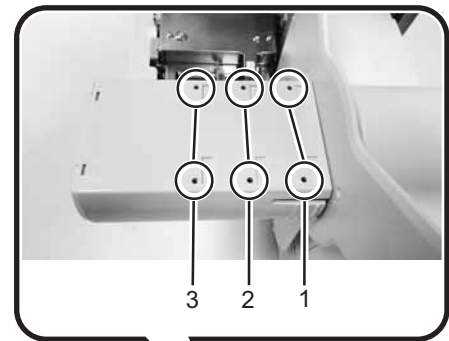

4. Load the media to the **roll media supply spindle**. Make sure the media leader is pull out from the bottom and the printed side is facing upwards. Push the roll firmly towards the end of the spindle.

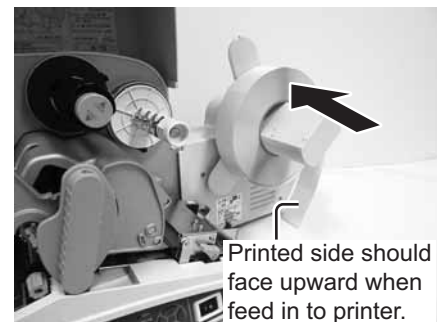

5. Attach the **roll media guide** back and make sure that the **roll media guide** pushes snugly against the media roll to prevent media drift during printing.

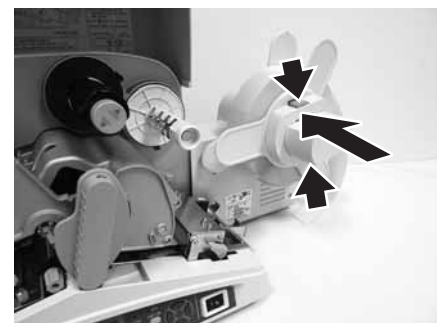

2.3 LOADING MEDIA (cont'd)

6. Press the purple **Lid Latch lever** to open the hinged **Lid Latch**. Then, release the purple **head lock lever** by turning counter clockwise. The print head assembly will be lifted up to allow media loading.

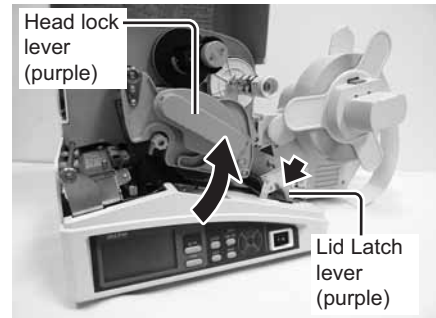

7. Load the media from the rear, so that the media passes through the **media guide** and underneath the **pitch sensor guide**, until the leading edge of the first media is on the **platen roller**.

Inspect the media routing and verify that the path matches that illustrated on the inner side of the main cover.

8. Loosen the **Media guide adjustment knob** and manually adjust the **media guide** inward so the media is prevented from moving horizontally. Retighten **knob**.

9. Lower and lock the **Lid latch**, remount the **print head** by turning the **head lock lever** clockwise until it latch on. The **print head** should lock into place firmly.

10. After loading the media, close the **main cover**. You may need to set the Media type selection and set the Cutter sensor adjustment. Refer to **Section 2.4 Media Type selection** and **Section 2.5 Cutter Sensor Adjustment** for more details.

Note:

Be careful not to get your fingers caught at the bottom edge when you are closing the main cover.

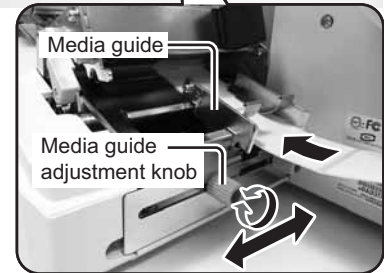
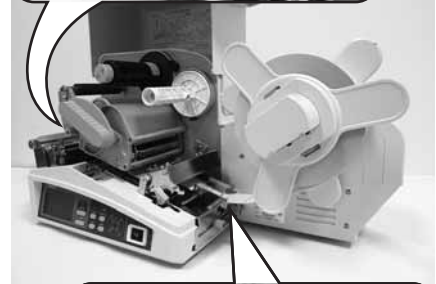
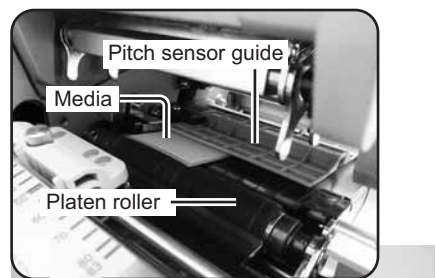

Caution

- When replacing media, bear in mind that the print head and its surrounding area remain hot. Keep your fingers away from these areas to prevent injury.
- Avoid touching even the edge of the print head with your bare hands.

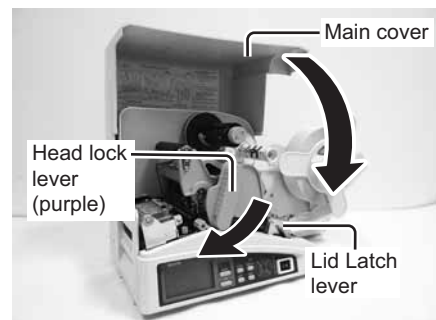

2.3 LOADING MEDIA (cont'd)

Automatic Feeding Function

The automatic feeding function automatically transports media detected with the **Jump hole sensor** to the **Print head** position when media is feed in from the **Media feed-in guide** of the printer.

When leading edge of the media is inserted to the lid latch part while the printer is in the Offline state after the head and lid latch are opened/closed, this function uses the jump hole sensor to detect the media and then performs the automatic feed operation.

Due to different types of media available, it is recommended to load the media manually as mentioned in the prior section for more precise motion of the media.

Overview of the media and ribbon loading path

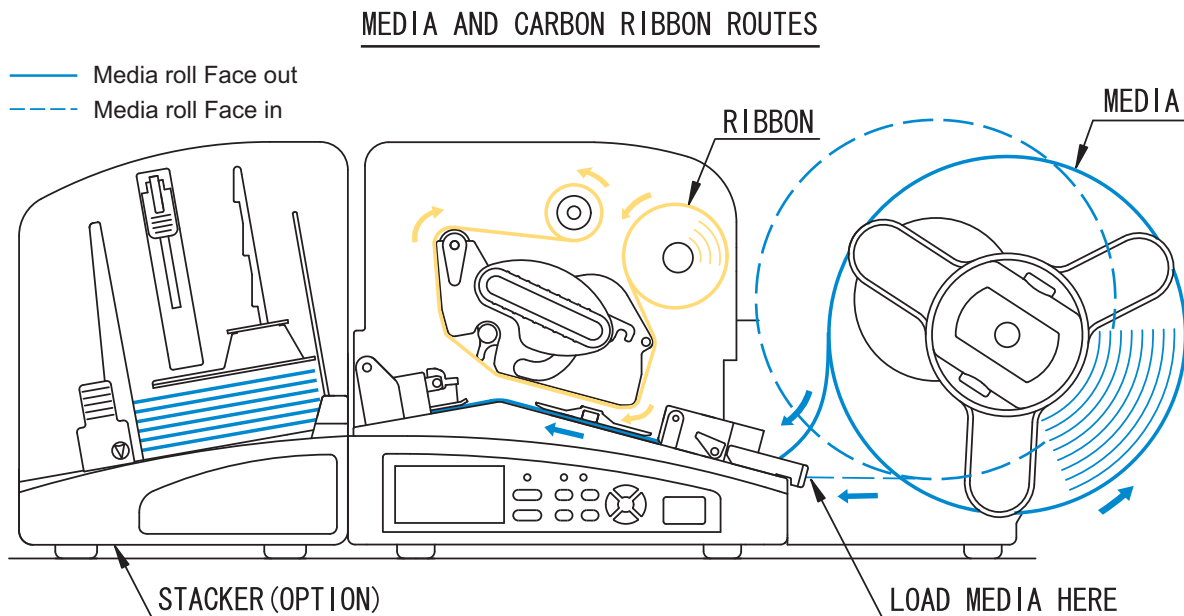

2.4 MEDIA TYPE SELECTION

After first loading of the media or you have changed the media type, you need to set the Media selection of the printer. Media selection is to select the media used and enable the appropriate sensor.

1. Turn the power On.
Error message is displayed on the LCD screen.
2. Release the purple **head lock lever** by turning counter clockwise and then clockwise to latch the **head lock lever** back to position.
The printer enters Offline mode and the media type is displayed on the screen.
3. In Offline mode, press the **PAPER** button repeatedly, the media selection will advance cyclically.
Center Hole, I-Mark Tag, Side hole Tag, Edge Tag, Label Gap, Label I-Mark and Not Sensor can be selected. Select the paper type according to the loaded media and the paper sensor is to be used. Please refer to **Media (PAPER) selection** in **Section 3.3.2 Offline Mode** for details.

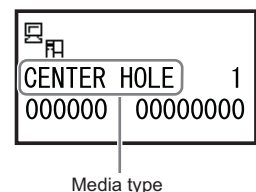

2.5 CUTTER SENSOR ADJUSTMENT

This adjustment is for R-Corner tag (Notch/Edge), Center-Hole and Side-Hole tags only. The Cutter sensor must be adjusted correctly even though the Cutter is disabled. If the Cutter sensor is not properly set, the printer will prompt “CUT SENSOR ERROR” when you try to feed tags.

1. With the power supply is off, lift up the **main cover**.

Note:

Make sure that the cover rests firmly so that it will not fall forward and injure your hands.



2. The **purple Cutter sensor assembly** is located in front of the **print head assembly**. Loosen the **Sensor adjustment thumbscrew** on the **purple Cutter sensor assembly**.

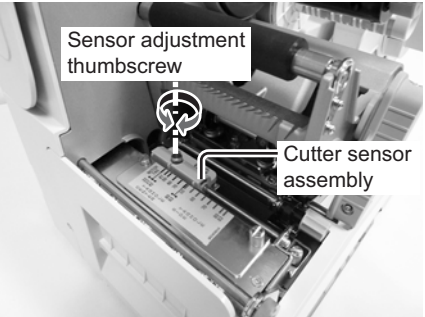

3. Slide the **Cutter sensor assembly** and align the **pointer** on the **Cutter Sensor Assembly** to the position of the tag registration mark using the **scale**.
The **scale** used depends upon the type of tag selected (such as R-Corner/Notch, Center-Hole or Side-Hole). The setting corresponds to the width of the media. (For example, if you are using center hole tags that are 70mm wide, the pointer should be set at the **70** mark of the black scale).

Types of Tags	Scale used
R-Corner /Notch/ Edge	Set at “NOTCH TAG” marking
Center-Hole	Black scale (32 - 83)
Side-Hole	Blue scale (50 - 83)

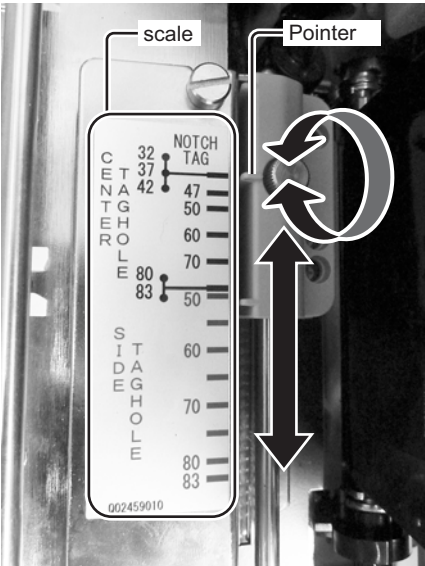

4. After adjusting the **Cutter sensor**, tighten the **Sensor adjustment thumbscrew** and close the Cover.

2.6 LOADING THE CARBON RIBBON

The TG3 series printer enables two types of printing, **Thermal transfer** and **Direct thermal**. **Thermal transfer** paper media requires the use of carbon ribbon for print application. In such a scenario, it is the carbon ribbon that contains the ink that will be transferred to the media. **Direct thermal** paper media has a coating on the surface that is made visible through the application of heat from the print head. In this case, there is no need of loading the carbon ribbon.

Caution

- When replacing carbon ribbon, bear in mind that the print head and its surrounding area remain hot. Keep your fingers away from these areas to prevent injury.
- Avoid touching even the edge of the print head with your bare hands.

1. With the power supply is off, lift up the **main cover**.

Note:

Make sure that the cover rests firmly so that it will not fall forward and injure your hands.



2. Turn the purple **head lock lever** counter clockwise to release it.
The print head assembly will be lifted up.

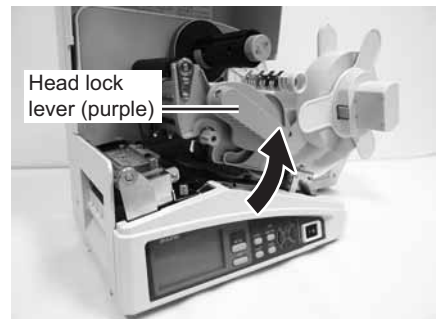

3. Open the carbon ribbon package, and then load the ribbon on the **ribbon supply spindle**. Push it inwards all the way, with the ribbon winding in a counter-clockwise direction. The dull side (inked side) of the ribbon should be facing down as it travels through the print head assembly.

Note:

Use only genuine SATO carbon ribbons for maximum print quality and printer durability.

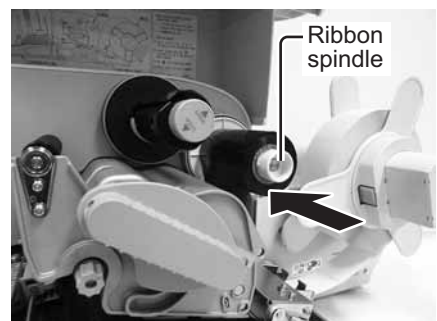

2.6 LOADING THE CARBON RIBBON (cont'd)

4. From the **ribbon supply spindle**, pass the carbon ribbon underneath the print head assembly to the **ribbon take-up spindle**. Route the ribbon behind and over the top of the **ribbon take-up spindle** and place the leader portion of the carbon ribbon to the **rubber pad** of the **ribbon take-up spindle**.

Confirm that the ribbon has been loaded as shown in the figure on the right or as illustrated on the inner side of the main cover

Note:

Do not pass the carbon ribbon underneath the pitch sensor unit.

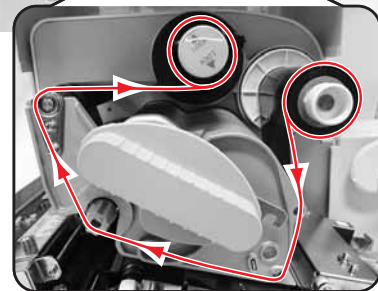
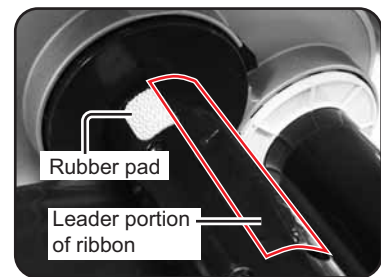

5. Then turn the **take-up spindle** several times in the direction of counter-clockwise to wind the ribbon around the **spindle**.



6. Remount the **print head** by turning the **head lock lever** clockwise until it latch on. The print head should lock into place firmly.
7. After loading the media and the carbon ribbon, close the **main cover**, turn on the printer and do a test print to check that the media roll has been loaded properly. See **Section 3.12 Test Print Mode** for instructions on how to run test print.

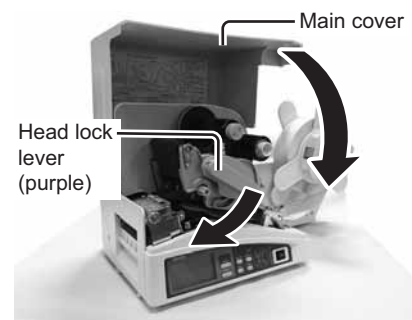

2.7 REMOVE THE CARBON RIBBON

After the carbon ribbon has used up to the end of the roll, remove the wound-up carbon ribbon from the printer.

1. With the power supply is off, lift up the **main cover** and release the purple **head lock lever** by turning counter clockwise.



2. Turn the purple **knob** of the **ribbon take-up spindle** in counter clockwise direction and then pull outward. The **ribbon take-up spindle** is released and the wound-up carbon ribbon is loosen.

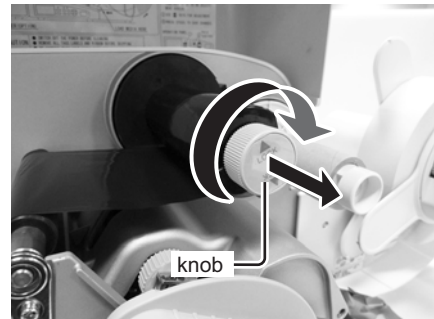

3. Remove the wound-up carbon ribbon from the **take-up spindle** in the direction of the arrow.

Caution:

Be careful when removing the carbon ribbon, your hands may get dirty while handling it.

4. Remove the empty **core** from the **ribbon supply spindle**.
5. Push back the purple **knob** of the **ribbon take-up spindle** and turn in clockwise direction to lock.



2.8 BASIC CONNECTIONS

This section explains the power cable and interface cable connection procedures.

2.8.1 Install and Connecting the Interface board

This printer has a flexibility to select a suitable interface options for communication to the host computer. The following Plug-in interface boards are available.

- RS-232C (High-speed) interface board
- IEEE1284 interface board
- LAN interface board
- Wireless/wired LAN interface board
- USB interface board

*Installation of the interface board should be done by SATO authorised servicing personnel.

1. Make sure that power cable is not connected to the printer.
2. Remove the **screw** securing the **Interface plate** on the back of printer. Remove the **Interface plate** and keep it for future use.
3. Align the **Interface board** with the guide of the interface slot opening as shown.
4. Lightly push the **interface board** into the printer until you feel the connection of the **interface board**.

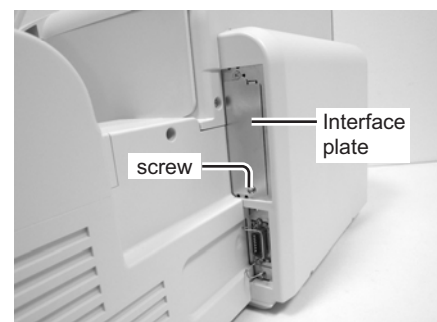

3. Align the **Interface board** with the guide of the interface slot opening as shown.
4. Lightly push the **interface board** into the printer until you feel the connection of the **interface board**.

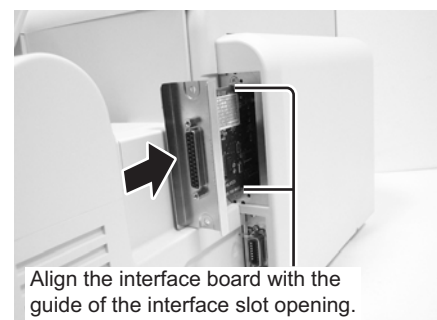

5. Secure the **interface board** with two **screws**.
6. Connect the **interface cable** from the host computer to the printer.
Use the cable that is compatible with the standard of the interface board as stated in **Section 7: Interface Specifications**. Make sure the cable is correctly oriented. Secure the printer with one hand, and insert the cable firmly.

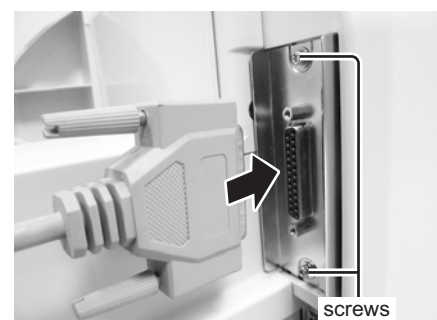

2.8 BASIC CONNECTIONS (cont'd)

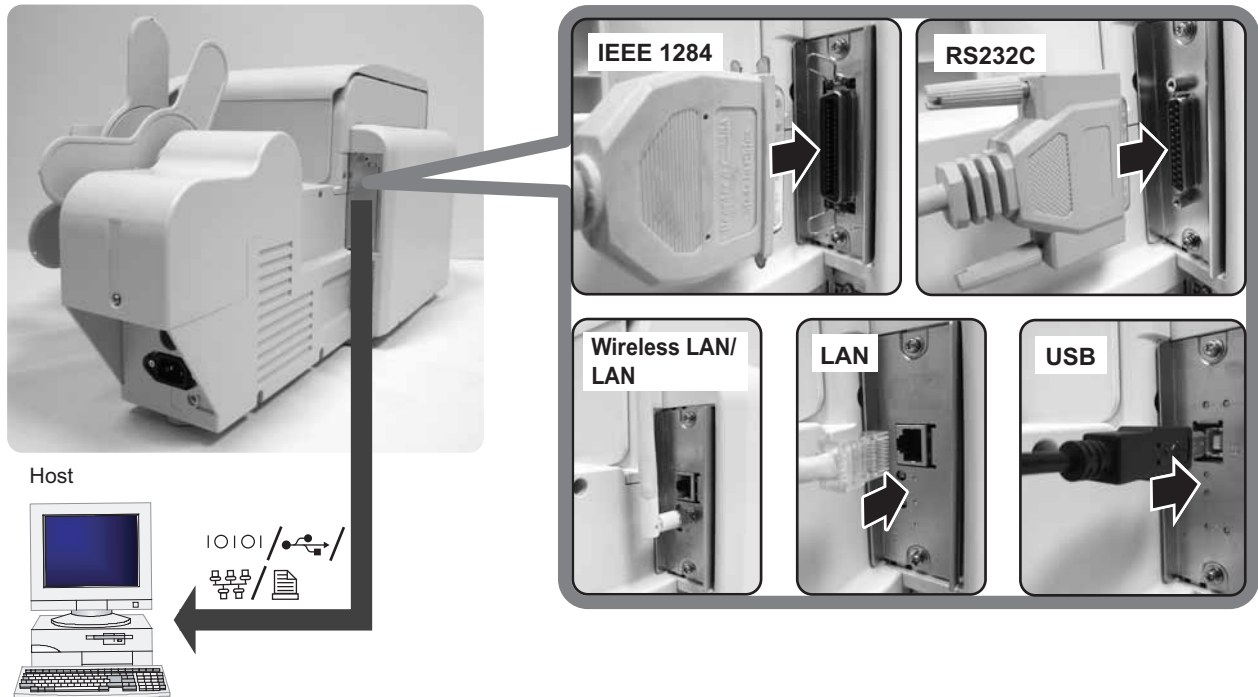

Caution

- Always turn the printer off before attaching or detaching an interface card. Otherwise, severe electrical damage may be incurred, or bodily injury may be sustained.
- Never connect or disconnect interface cables (or use a switch box) with power applied to either the host or printer. This may caused damage to the interface circuitry in the printer/ host and is not covered by warranty.

2.8.2 To Configure the Connected Interface

After connection, you need to set various parameters governing the use of interface cards. Please refer to **Section 3.7 Interface Mode** for details on Interface Mode.

2.8 BASIC CONNECTIONS (cont'd)

2.8.3 Connecting the Power Cable



Warning

- Be sure to connect the ground wire. Failure to do so may cause an electric shock.
- Do not operate the power switch or insert/remove the power cable while your hands are wet. Doing so may cause an electric shock.



Caution

The power cable and the AC adapter provided with this printer are for use with this printer only. They cannot be used with other electrical devices.

1. Connect the power cable to the **AC IN** power terminal on the rear panel of the printer.
Make sure that the connector is correctly oriented.
Secure the printer with one hand, and insert the connector firmly.

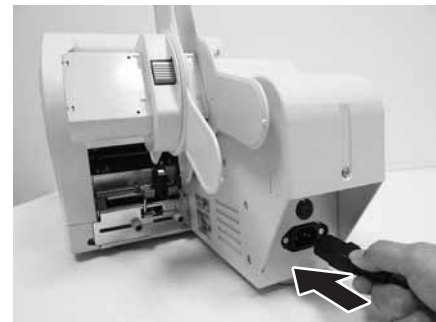

2. Insert the power plug into a AC power outlet.
Make sure that the AC voltage of your region is within the range of AC 100 to 240V, 50/60 Hz.
A 3-pin plug is attached to the power cord provided with your printer. One of these pins is the ground wire.
If the power outlet that you plan to use is a 3-pin type, simply insert the power plug as is.

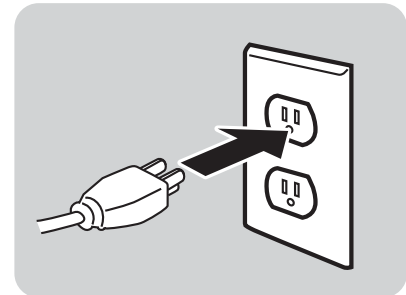

* The shape of the power plug may vary depending on the location where the printer was purchased.

2.8 BASIC CONNECTIONS (cont'd)

2.8.4 Turning On the Power

Warning

Do not operate the power switch or insert/remove the power cable while your hands are wet. Doing so may cause an electric shock.

Turn on the power switch located on the printer's operation panel.

Press the side of the switch marked "I".

- When you turn on the power, the printer start-up and detect for the loaded media and ribbon. If the media are correctly loaded, "ONLINE" appears on the display.
- If the media and carbon ribbon are not loaded or properly loaded, the printer will prompt an error message. Load the media and carbon (refer to **Section 2.3 Loading Media** and **Section 2.6 Loading the Carbon Ribbon**) and then press **ONLINE** button.

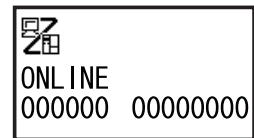
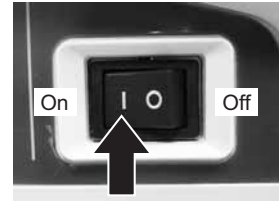

2.8.5 Turning Off the Power

When you have completed the printing job, turn the printer off.

1. Press the **ONLINE** button to put the printer offline. Be sure to confirm that the printer is in the offline status before turning it off. If there is any printed media remaining in the printer, press **FEED** button to forward feed the media and cut it off.
2. Turn off the power switch on the printer's operation panel. Press the side of the switch marked "O".

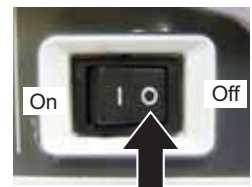
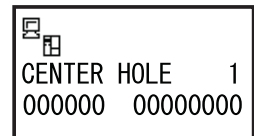

2.9 LCD POWER SAVING MODE

The LCD backlight is turned off for power saving when the printer is not operated for a specified period of time. The time to turn off the LCD backlight can be set via the LCD POWER SAVING MODE SETTING screen in the Advanced Mode. Please refer to **Section 3.9 Advanced Mode** for instructions.

2.9.1 Turning off the LCD Backlight

At the following conditions, the LCD backlight is turned off when the time specified on the LCD POWER SAVING MODE SETTING screen has elapsed. In this function, only the LCD backlight is turned off and the on-screen message remains the same.

- The printer has not received the print data (ESC+A~ESC+Z) in various interfaces.
 - * Omitting status return request and cancel request of each protocol and/or incorrect data.
- No button is pressed.
- The printer is not in error state.
- The printer is neither printing nor feeding paper.
- The printer is in online state, offline state, HEX dump mode or SEMBL mode.
 - * This function is disabled in the Download Mode.

2.9.2 Turning on the LCD Backlight

Following one of the instructions below will turn on the LCD backlight again.

- The printer received the print data from various interface boards.
 - * Omitting status return request and cancel request of each protocol and/or incorrect data.
- Some buttons are pressed.
- Printer error such as “Head open” occurred.
- The printer started printing operation.

Pressing any button while the LCD backlight is off will turn on the LCD backlight only.

(The printer does not go offline by pressing the ONLINE button when the LCD backlight is off in online state.)

This page is intentionally left blank

3

OPERATION AND CONFIGURATION

Before using the printer, it is best to read this manual thoroughly first. Otherwise, you may disturb default settings around which the instructional procedures in this manual are based upon.

The printer may be manually configured via the **ONLINE**, **FEED**, **CUTTER**, **EJECT**, **FUNCTION**, **PAPER** and arrow buttons with the LCD display on the operator panel of printer. All of the printer's buttons are used either singularly, or in conjunction, to perform configuration activities.

Many of these settings can also be controlled via software commands and in case of conflict between software and control panel settings, the printer will always use the last valid setting. If you load a label job that includes software settings and then enter a new setting via the LCD panel, the manually set values will be used by the printer. If you set the values manually and then download a job with software settings, the software settings will be used.

3.1 OPERATOR PANEL

The operator panel locate on the side consist of three LED indicators, ten momentary contact buttons and one LCD display. There are eight adjustment potentiometers and a DIP switch located on the right bottom side when you are facing the printer. Remove the covers in order to access for adjustment.

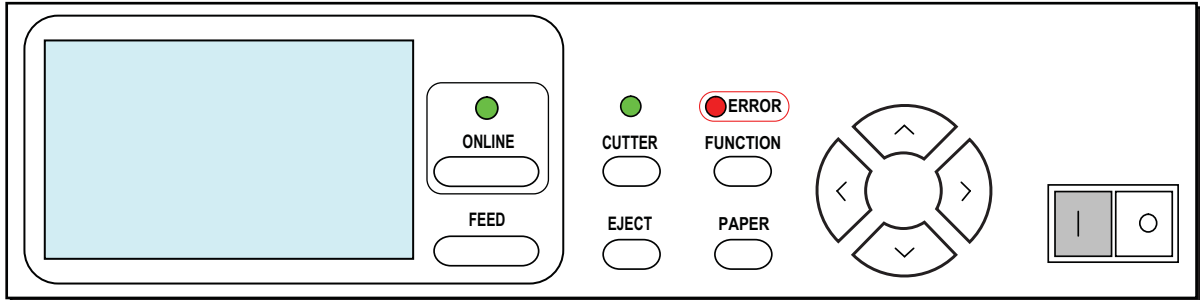

- **LED indicators**

When the printer is in normal mode, these three indicators notify the user of various status conditions:

LED Indicator	Color	Functions
ON LINE	Green	Illuminates when printer is ready to receive data or is in printing mode (Online). Light is off when the printer is in offline or error state. Blinks when the printer detects buffer near full.
CUTTER	Green	Illuminates in cutter mode.
ERROR	Red	Illuminates or blinks when detecting printer error.

- **ONLINE** button

Pressing this button toggles the printer between the online and offline mode. When the printer is online, it is ready to receive data from host. This button acts as a pause during a print job by taking the printer offline.

This button also function as returning to the previous item during various printer setting with the LCD display.

- **FEED** button

Pressing this button feeds one blank label through the printer when the cutting operation is disabled. When the cutting operation is enabled, the printer will feed, cut and backfeed a single label.

This button also function as item selection during various printer setting with the LCD display.

- **CUTTER** button

Pressing this button to enable or disable the cutting operation.

- **EJECT** button

When cutting operation is disabled, valid tags will be fed and cut before backfeed motion.







When cutting operation is enabled, valid tags will be fed and cut before backfeed motion.

3.1 OPERATOR PANEL (Cont'd)







- **FUNCTION** button
Recalls the Mode Selection screen for selection of various function menus. Also returns the user to the Mode Selection screen from other menus.
- **PAPER** button
Pressing this button to select the paper type of the media loaded.
- Arrow buttons
These cause the cursor to shift up, down, left and right on the screen in various setting modes.
- **LCD Display**
Up to five icons and two lines of alphanumeric text can appear on the LCD display to indicate the current printer status.
The same area can also display two lines of alphanumeric text during various setting modes.

List of Icons

[Mode display]

No	Icon	Description
1		Displayed when printer is in online state
2		Displayed when printer is in offline state
3		Displayed when printer is in Test Print Mode and HEX Dump Print Mode
4		Displayed when printer is in SEMBL Mode
5		Displayed when printer is in Download Mode
6		Displayed when Keypad is connected to printer



















[Mode selection screen]

No	Icon	Description
1		Changing to Normal Mode
2		Changing to User Mode
3		Changing to Interface Mode
4		Changing to SEMBL Mode
5		Changing to Advanced Mode
6		Changing to Dump Print Mode
7		Changing to RFID User Mode * This icon will be displayed only when RFID function is enabled.





3.1 OPERATOR PANEL (Cont'd)

List of Icons (Cont'd)

[Error-related]

No	Icon	Description
1		Displayed when detecting Label End
2		Displayed when detecting Ribbon End
3		Displayed when detecting Sensor Error
4		Displayed when detecting Media Error
5		Displayed when detecting Head Open
6		Displayed when detecting electrical disconnection of print head
7		Displayed when detecting Communication Error
8		Displayed when detecting Receive Buffer Over
9		Displayed when detecting Item No. Error or BCC Error
10		Displayed when detecting Cutter Error
11		Displayed when having write failure to main ROM or when detecting Kanji ROM error
12		Displayed when detecting Calendar Error
13		Displayed when having write failure to RFID tag
14		Displayed when detecting a command error due to the message display function of command error
15		Displayed when having a memory access error or when running out of memory space
16		Displayed when stacker or rewinder became full
17		Displayed when detecting printer error other than the above
18		Error number corresponding to each error

[Warning-related]

No	Icon	Description
1		Displayed when detecting Ribbon Near End
2		Displayed when detecting Command Error
3		Displayed when detecting Receive Buffer Near Full
4		Displayed when detecting electrical disconnection of print head

3.2 OPERATING MODES

The operating status of this printer can be set within one of the following modes:

1. Normal mode (including Online/Offline modes)
2. Adjustment screen
3. Cancel Print Job mode
4. Printer Setting mode:
 - User mode
 - Interface mode
 - SEMBL mode
 - Advanced Mode
 - Hex Dump mode
 - RFID User mode
5. Test Print mode
6. Default Setting mode
7. Maintenance mode
8. Service mode
9. RFID mode
10. Download mode

The various modes are accessed by pressing the **ONLINE** button, **FEED** button, **FUNCTION** button, **PAPER** button and arrow buttons while the printer is Off, On or with certain printer settings in force.

3.2 OPERATING MODES (Cont'd)

The following flow chart provides a clear summary of all the modes and their access method.

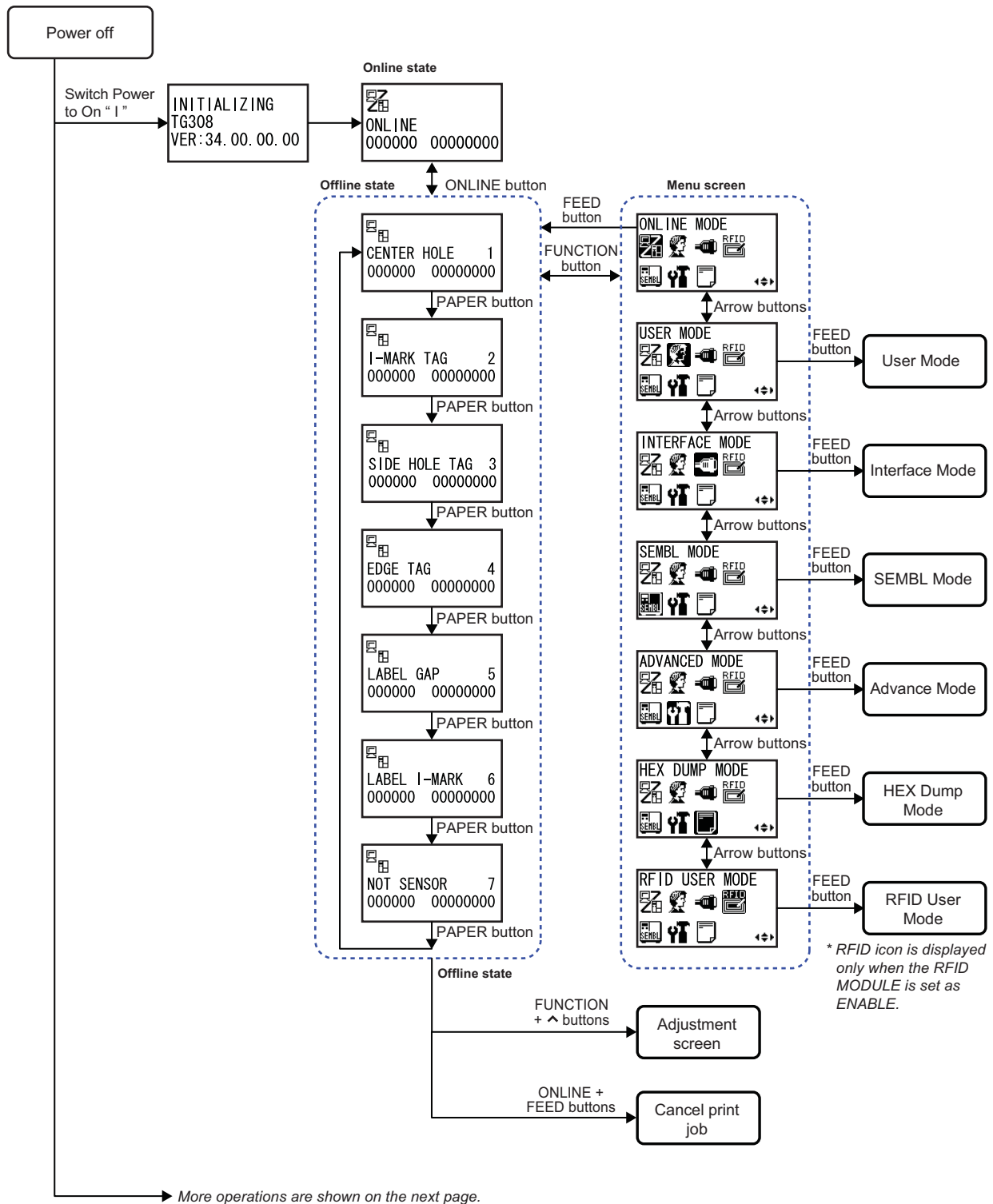

3.2 OPERATING MODES (Cont'd)

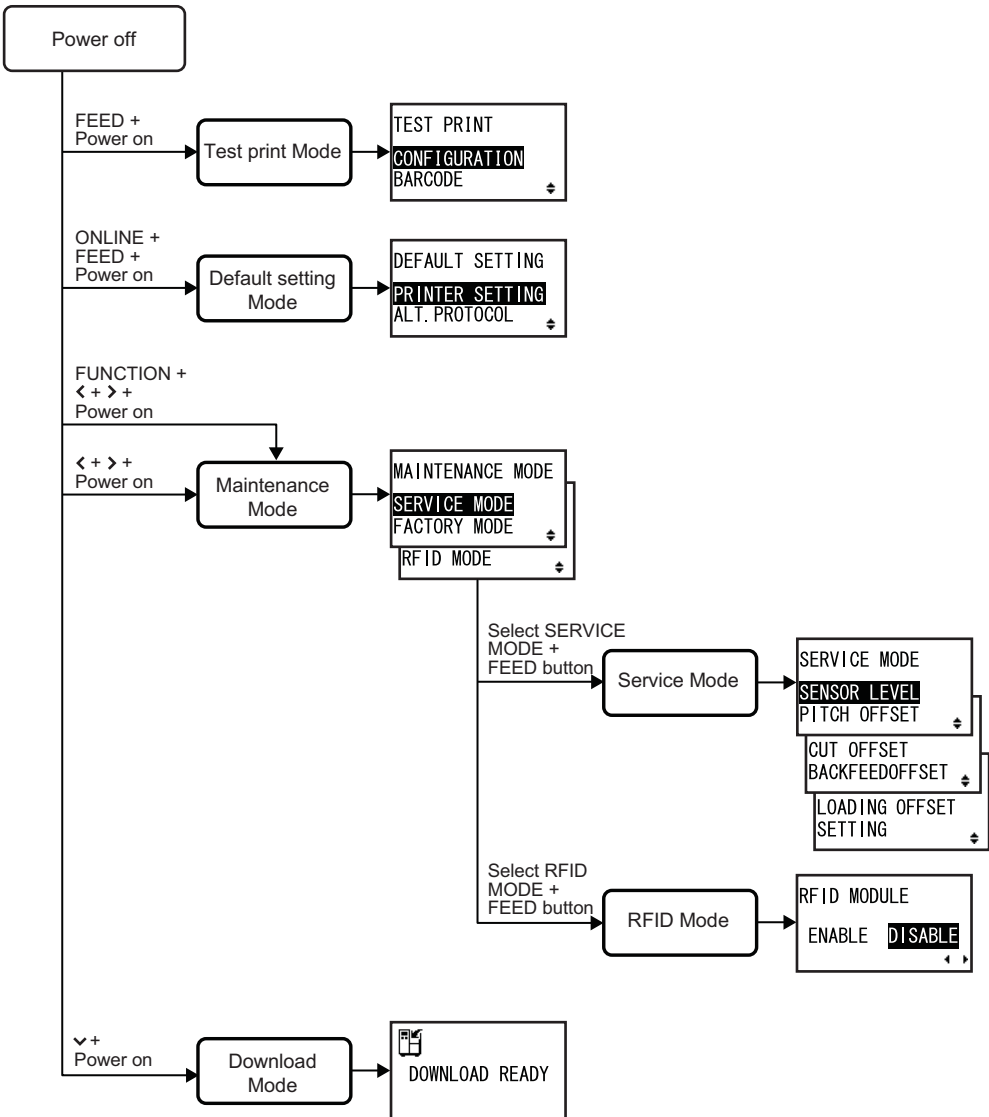

3.3 ONLINE AND OFFLINE MODES

The general and basic operation of the TG3 series printer is via the Normal mode, which consists of the ONLINE and Offline modes.

3.3.1 Online Mode

Pressing the **ONLINE** button causes the printer to go ONLINE or Offline (Paper selection screen) alternately.

When the printer is ONLINE, the following activities will be possible:

- The printer is ready to receive print data from the computer or other connected devices
- The printer is ready to start printing

The number displayed on the bottom line of LCD panel shows the media quantity status. As soon as a print job is received, the display on the bottom left will indicate the number of labels to be printed. When the label job begins to print, this display will indicate the remaining number (countdown) of labels to be printed. The total printed quantity since power up will be indicate at the bottom right of display.

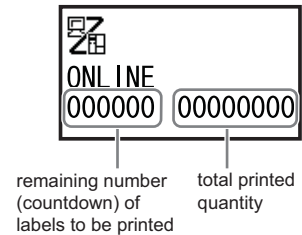

3.3.2 Offline Mode

When the printer is ONLINE, pressing the **ONLINE** button once will cause the printer to go Offline. Any printing job will be PAUSE once the printer is brought Offline.

When the printer is Offline, the activities for ONLINE mode are no longer possible, but the following activities will be possible:

- **Media (PAPER) selection**

Media selection is to select the media used and enable the appropriate sensor. When you press the **PAPER** button repeatedly during Offline mode, the media selection will advance cyclically as shown. Select the media type according to the loaded media and the media sensor is to be used.

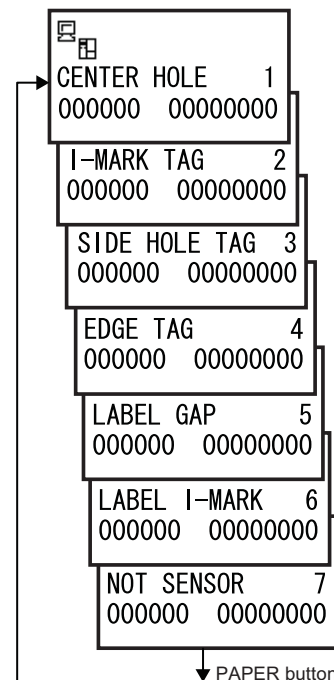
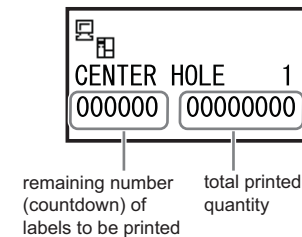

Media selection	Loaded media on the printer
CENTER HOLE 1	When center hole tags were loaded.
I-MARK TAG 2	When I-Mark tags were loaded.
SIDE HOLE TAG 3	When side hole tags were loaded.
EDGE TAG 4	When Edge (Notch) tags were loaded.
LABEL GAP 5	When labels with gap were loaded.
LABEL I-MARK 6	When labels with I-Mark were loaded.
NOT SENSOR 7	When no paper sensor is set, continuous printing.

Note:

If the Media (PAPER) selection is not properly set, SENSOR ERROR will be prompt when the printer is in ONLINE mode.

3.3 ONLINE AND OFFLINE MODES (Cont'd)

- The printer can feed a blank label/ tag when you press the **FEED** button.
- The printer can be switched to CANCEL PRINT JOB modes when you press the **FEED** and **ONLINE** button simultaneously.
- The printer goes to Adjustment screen when you press the **^ arrow** button and **FUNCTION** button simultaneously.
- In OFFLINE mode, press the **FUNCTION** button to access the icon-based printer settings menu. Using the arrow buttons, you can access the ONLINE mode, USER mode, INTERFACE mode, SEMBL mode, ADVANCED mode and HEX DUMP mode from here. These modes will be discussed in subsequent sections.

3.3.3 To Adjust the Screen Contrast

In Normal mode (ONLINE or Offline), press the </> arrow buttons repeatedly to adjust the contrast.

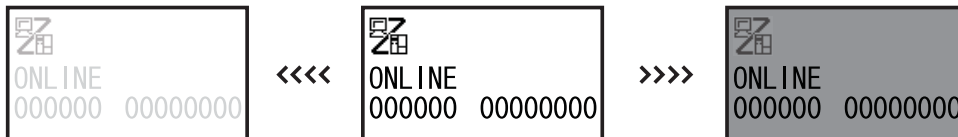

3.4 ADJUSTMENT SCREEN

The printer has a quick access to the Adjustment screen for setting the print position, stop position and the print darkness. These adjustments are in conjunction with the configuration adjustments done in the Service mode menu and the User mode menu.

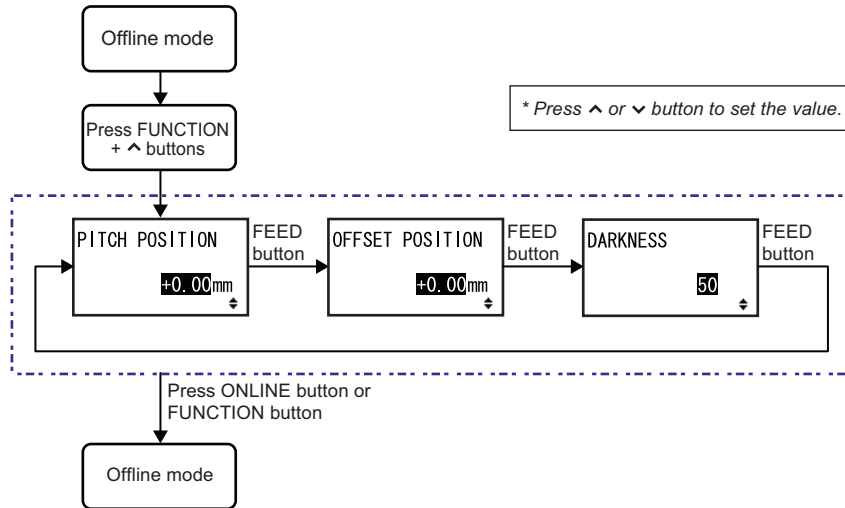

1. When the printer is Offline, pressing both the **FUNCTION** and **^ arrow** buttons at the same time will switch the printer to Adjustment mode. The PITCH POSITION screen is displayed.
2. Press **^/v arrow** buttons to set the desired value and press **FEED** button to save the setting and proceed to the next Adjustment screen.

Menu	Description
	Adjusts the print position or reference point where the printings begins vertically, relative to the leading edge of each media. Setting value is adjustable by 0.25mm regardless of print resolution. Setting range is ±3.75mm and the initial value is +0.00mm.
	Adjust the stop (cut) position of each media after printing. Setting value is adjustable by 0.25mm regardless of print resolution. Setting range is ±3.75mm and the initial value is +0.00mm.
	Adjust the print darkness of the print-out. Setting range is between 00 and 99, and the initial value is 50. Note: It is not advisable to set the print darkness to the higher position as a darker print-out requires the print head to operate in a higher temperature. Operating in high temperature may damage the print head in a long run.

3. After adjustment, press **ONLINE** button or **FUNCTION** button to exit the Adjustment screen and returns to Offline mode.
 Pressing the **ONLINE** button or **FUNCTION** button before pressing the **FEED** button will not save the adjustment.
 You may wish to print a test print after completing the adjustments to ensure they are correct. Refer to **Section 3.12 Test Print Mode** for details.

3.5 CANCEL PRINT JOB MODE

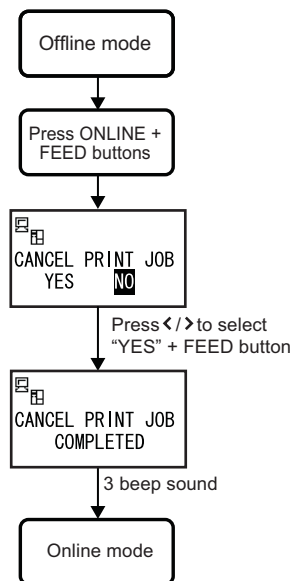

1. When the printer is Offline, pressing both the **ONLINE** and **FEED** buttons at the same time will switch the printer to CANCEL PRINT JOB mode. The menu for canceling the print job then appears.
2. Press </> **arrow** buttons to switch between the selection, YES or NO. The highlight on display indicates the selected option. The default setting is NO.
If the printer has a print job in memory, selecting YES will cause the job to be cleared.

Notes:

- Be sure you want to cancel the print job before selecting YES as the job cannot be recovered and will have to re-transmit to the printer.
 - Press **FUNCTION** button to exit the CANCEL PRINT JOB mode without clearing the print data.
3. Press **FEED** button to activate the selection.
If YES is selected, the message CANCEL PRINT JOB COMPLETED will display with 3 beeps sound and then return to Offline mode. All the print jobs were cleared from memory.

3.6 USER MODE

The following settings are available in the User Mode.

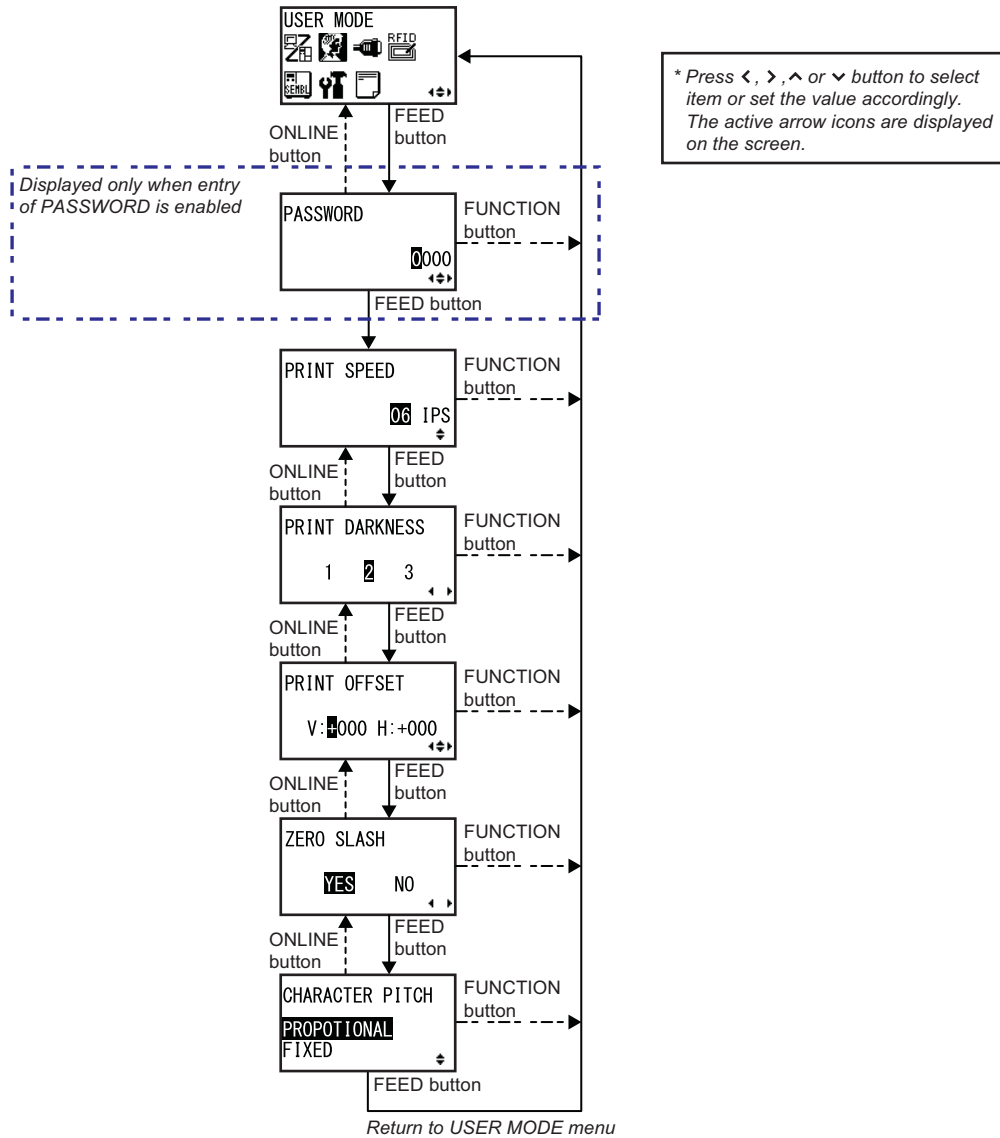





1. During Offline mode, press **FUNCTION** button to display the operational icon menu. Press **arrow** buttons to select USER MODE.
2. When USER MODE screen is displayed, press the **FEED** button to enter to User mode for adjustment.

Note:
PASSWORD may prompt on the display if SET PASSWORD is set to ON in the Service mode. Please refer to **Section 3.15 Service Mode** for details in password inputting.
3. PRINT SPEED is first displayed. Press the **FEED** button repeatedly will switch to the next setting options as shown above. To return to the previous setting option, press **ONLINE** button.
4. When the desired setting option is displayed, press **arrow** buttons to select the item or to set the value and then press **FEED** button to save the setting.

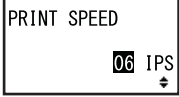
You may wish to print a test print after completing the adjustments to ensure they are correct. Refer to **Section 3.12 Test Print Mode** for details.

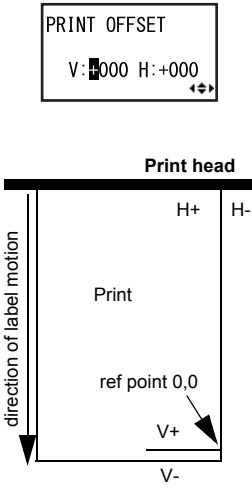
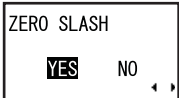
3.6 USER MODE (Cont'd)

USER MODE							
Menu	Description						
	<p>Adjusts the print speed that does not compromise print quality. Setting range is between 02 and 10 IPS (inches per second) with a increment of 01 IPS cyclically. The initial value is 6 IPS.</p>						
	<p>This setting adjusts the print darkness of the print-out with reference to the setting of the DARKNESS in Adjustment screen. Setting value can be set from 1 (lightest) to 3 (darkest). The default setting is 2.</p>						
	<p>Print Position Offset—which refers to the vertical and horizontal shifting of the entire print area, relative to the start position of printing (V=0, H=0), defined by default to be the bottom right hand corner of the media.</p> <p>The V setting is for the Vertical print offset. A positive (+) offset means the printing is shifted towards the print head; a negative (-) offset means shifting away from the print head. If the PITCH POSITION setting has been used to offset the vertical start position, then all Vertical offset adjustments are made relative to that start position.</p> <p>The H setting is for the Horizontal print offset. The + or - prefix determines whether the offset is to the left or to the right of the reference point.</p> <p>Setting value is indicated by dot, and the initial value, regardless of print resolution, is V:+000 H:+000.</p> <p>Setting range differs by print resolution.</p> <table border="0"> <tr> <td>[8dots/mm]</td> <td>:L:±0 to 400</td> <td>H:±0 to 400</td> </tr> <tr> <td>[12dots/mm]</td> <td>:L:±0 to 600</td> <td>H:±0 to 600</td> </tr> </table>	[8dots/mm]	:L:±0 to 400	H:±0 to 400	[12dots/mm]	:L:±0 to 600	H:±0 to 600
[8dots/mm]	:L:±0 to 400	H:±0 to 400					
[12dots/mm]	:L:±0 to 600	H:±0 to 600					
	<p>You can use this setting to determine whether zeroes are printed with a slash across them or not. The zero slash can be set to either 0 or Ø.</p> <p>If YES, [0] will be accompanied by a slash.</p> <p>If NO, no slash will appear.</p> <p>The initial value is YES.</p> <p>* Slash zero (zero has a slash through it) is available in the following fonts: U, S, M, WB, WL, XU, XS, XM, XB, XL, Outline font</p>						
	<p>This setting determines whether the space surrounding each text character is of a fixed width, or whether that space is to be varied to be visually more pleasant and proportional.</p> <p>If selecting PROPORTIONAL, data will be printed without character spacing.</p> <p>If selecting FIXED, data will be printed with fixed character spacing.</p> <p>The initial value is PROPORTIONAL.</p>						

3.7 INTERFACE MODE

In this mode, you can set various parameters governing the use of interface cards.

3.7.1 Overview of Interface Mode Configurations

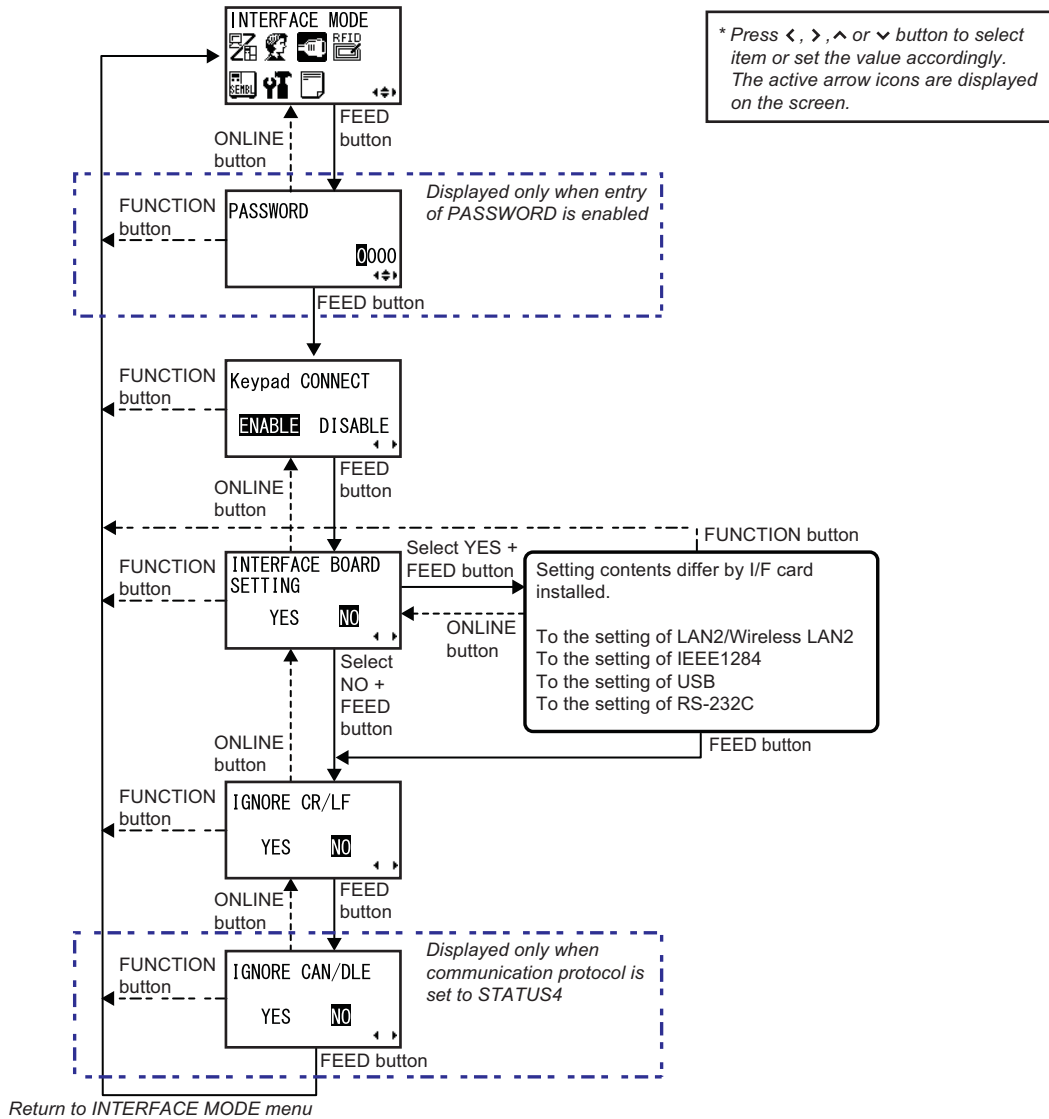

1. During Offline mode, press **FUNCTION** button to display the operational icon menu. Press **arrow** buttons to select INTERFACE MODE.
2. When INTERFACE MODE is displayed, press the **FEED** button to enter to Interface mode for adjustment.

Note:
PASSWORD may prompt on the display if SET PASSWORD is set to ON in the Service mode. Please refer to **Section 3.15 Service Mode** for details in password inputting.
3. Keypad CONNECT is first displayed. Press the **FEED** button repeatedly will switch to the next setting options as shown above. To return to the previous setting option, press **ONLINE** button.
4. When the desired setting option is displayed, press **arrow** buttons to select the item or to set the value and then press **FEED** button to save the setting.

3.7 INTERFACE MODE (Cont'd)

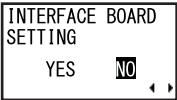
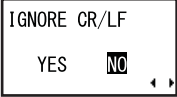
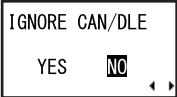
INTERFACE MODE	
Menu	Description
	<p>This screen shows the connection setting of input device (Keypad).</p> <p>ENABLE: If the input device is connected, print data from the device will be valid. If the device is disconnected, print data received from the PC will be valid. * The data received from the PC becomes invalid while the input device is connected.</p> <p>DISABLE: Only the print data received from the PC becomes valid. * The data received from the input device becomes invalid.</p> <p>The initial cursor position is at ENABLE. Connection status of input device can be checked by the status icon displayed in the Normal Mode. Note: Changed settings will be in effect from the next power on.</p>
	<p>This is a confirmation screen for setting the connected interface board configurations.</p> <p>If YES, it goes to the communication setting of the installed interface board. If NO, it goes to IGNORE CR/LF screen. The initial cursor position is at NO.</p>
	<p>This setting determines whether Carriage Return and Line Feed codes are processed or ignored. It only appears when an IEEE1284 interface is installed, and the Protocol option is set to STATUS4, for Receive Buffer in multi buffer mode.</p> <p>Select YES to ignore the codes, and NO to process them.</p>
	<p>This setting determines whether the CANCEL and DATA LINK ESCAPE codes are processed or ignored. It only appears when the communication protocol option is set to STATUS4.</p> <p>Select YES to ignore the codes, and NO to process them.</p>

3.7 INTERFACE MODE (Cont'd)



3.7.2 Enabling Interface Card Configuration

When INTERFACE BOARD SETTING is set to YES, the next display shows the connected interface card to be configured. Refer to the following flowcharts of the all setting and LCD display menus available for LAN/ Wireless LAN, IEEE1284, USB and RS-232C interface cards.

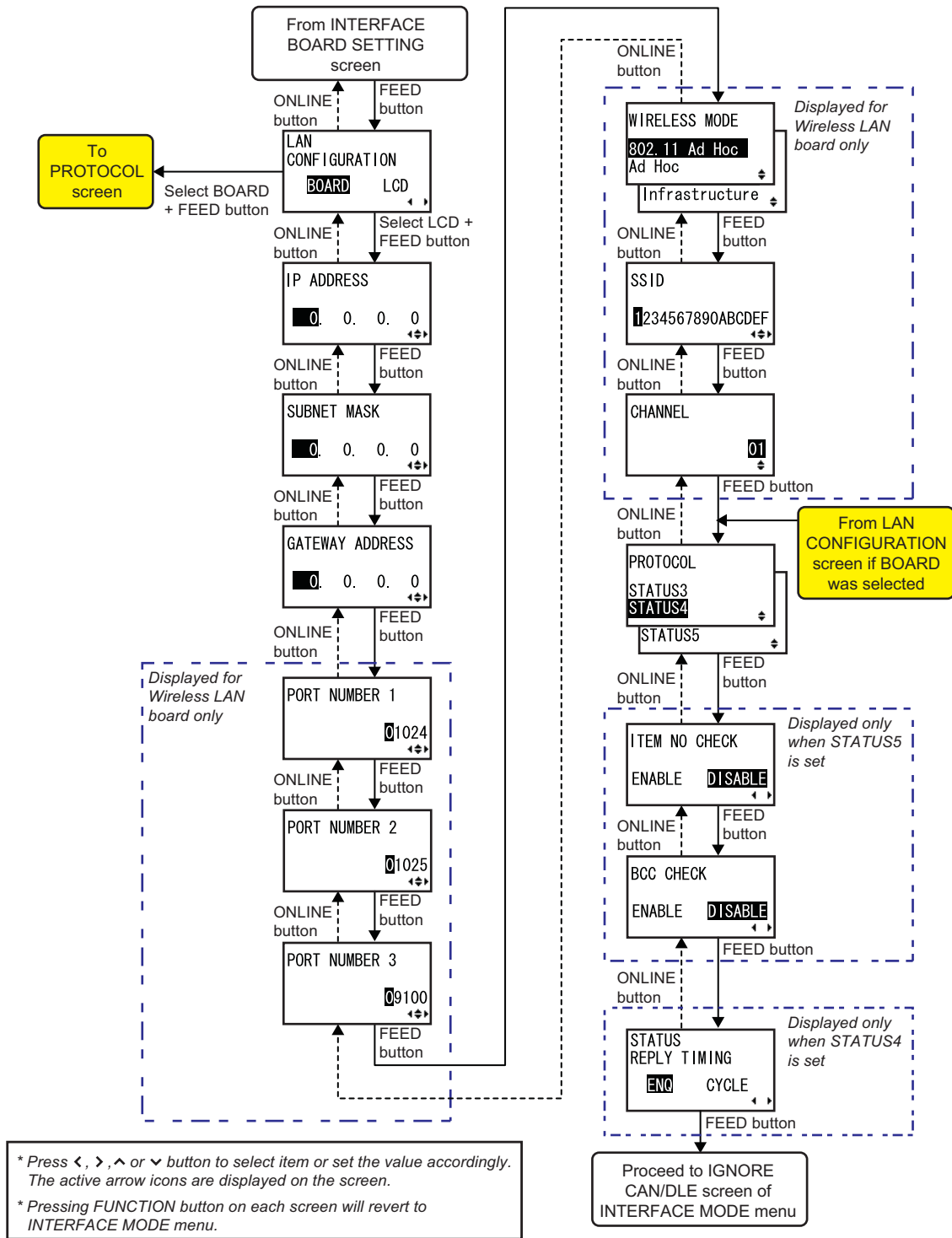

Setting of LAN/ Wireless LAN

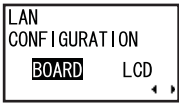
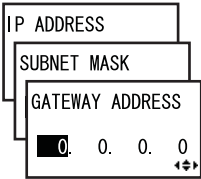
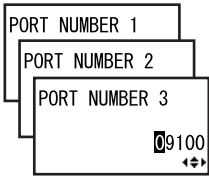
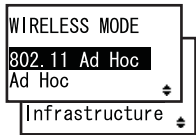
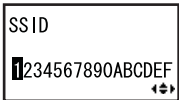

3.7 INTERFACE MODE (Cont'd)

LAN/Wireless LAN CONFIGURATION	
Menu	Description
	<p>This screen allows user to select the LAN/ Wireless LAN configurations based on either the setting on interface board or the setting of LCD.</p> <p>BOARD: Priority on current interface board settings Select BOARD and press FEED button will proceed directly to PROTOCOL setting.</p> <p>LCD: Priority on LCD settings Select LCD and press FEED button will continue to IP ADDRESS setting. The initial cursor position is at BOARD.</p> <p>Note: Changed settings will be in effect from the next power on.</p>
	<p>Setting the IP address, follow by the Subnet mask and then Gateway address of LAN/ Wireless LAN.</p> <p>Press ^/v arrow buttons to change the setting value and press </> arrow buttons to move the cursor to next digit.</p> <p>Press FEED button to save the setting.</p> <p>Note: Changed settings will be in effect from the next power on.</p>
	<p>Setting the Port number 1, 2 and 3 of Wireless LAN. These screens are displayed only when Wireless LAN interface board is installed.</p> <p>Press ^/v arrow buttons to change the setting value and press </> arrow buttons to move the cursor to next digit.</p> <p>Press FEED button to save the setting.</p> <p>Setting range is between 00000 and 65535. The initial value for Port number 1 is 01024, Port number 2 is 01025 and Port number 3 is 09100.</p> <p>Note: Changed settings will be in effect from the next power on.</p>
	<p>Select the Wireless LAN mode as 802.11 Ad Hoc, Ad Hoc or Infrastructure. This screen is displayed only when Wireless LAN interface board is installed. The initial selection is 802.11 Ad Hoc.</p> <p>Note: Changed settings will be in effect from the next power on.</p>
	<p>Set the SSID of Wireless LAN.</p> <p>Press ^/v arrow buttons to change the setting value and press </> arrow buttons to move the cursor to next digit.</p> <p>Alphabet (Upper/Lower case) and numeric up to 32 digits can be entered. The input character advances in following sequence with every pressing of the ^ arrow button. Pressing v arrow reverses the sequence.</p> <p>This screen is displayed only when Wireless LAN interface board is installed.</p> <p>Note: Changed settings will be in effect from the next power on.</p>
	<p>Set the Channel of Wireless LAN.</p> <p>Setting range is between 01 and 14.</p> <p>The initial value is 01.</p> <p>This screen is displayed only when Wireless LAN interface board is installed.</p> <p>Note: Changed settings will be in effect from the next power on.</p>

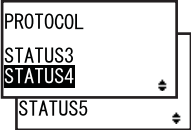
3.7 INTERFACE MODE (Cont'd)

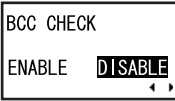
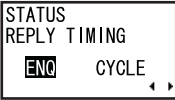
LAN/Wireless LAN CONFIGURATION	
Menu	Description
	<p>Select the communication protocol. STATUS3, STATUS4 and STATUS5 are available for selection when LAN/Wireless LAN interface boards are installed. The initial value is STATUS4. When STATUS3 is selected, the printer will proceed directly to IGNORE CR/LF menu. When STATUS4 is selected, the printer will proceed to STATUS REPLY TIMING menu. When STATUS5 is selected, the printer will proceed to ITEM NO CHECK menu.</p>
	<p>Set item number check function. ENABLE: Item number check is ON DISABLE: Item number check is OFF The initial value is DISABLE. This screen is displayed only when PROTOCOL is set to STATUS5.</p>
	<p>Set BCC check function. ENABLE: BCC check is ON DISABLE: BCC check is OFF The initial value is DISABLE. This screen is displayed only when PROTOCOL is set to STATUS5.</p>
	<p>Set status reply timing to the host. ENQ: Returns status after receiving Status Request (ENQ), which was sent from the host CYCLE: Returns status from the printer to the host at 500ms intervals The initial value is CYCLE. This screen is displayed only when PROTOCOL is set to STATUS4.</p>

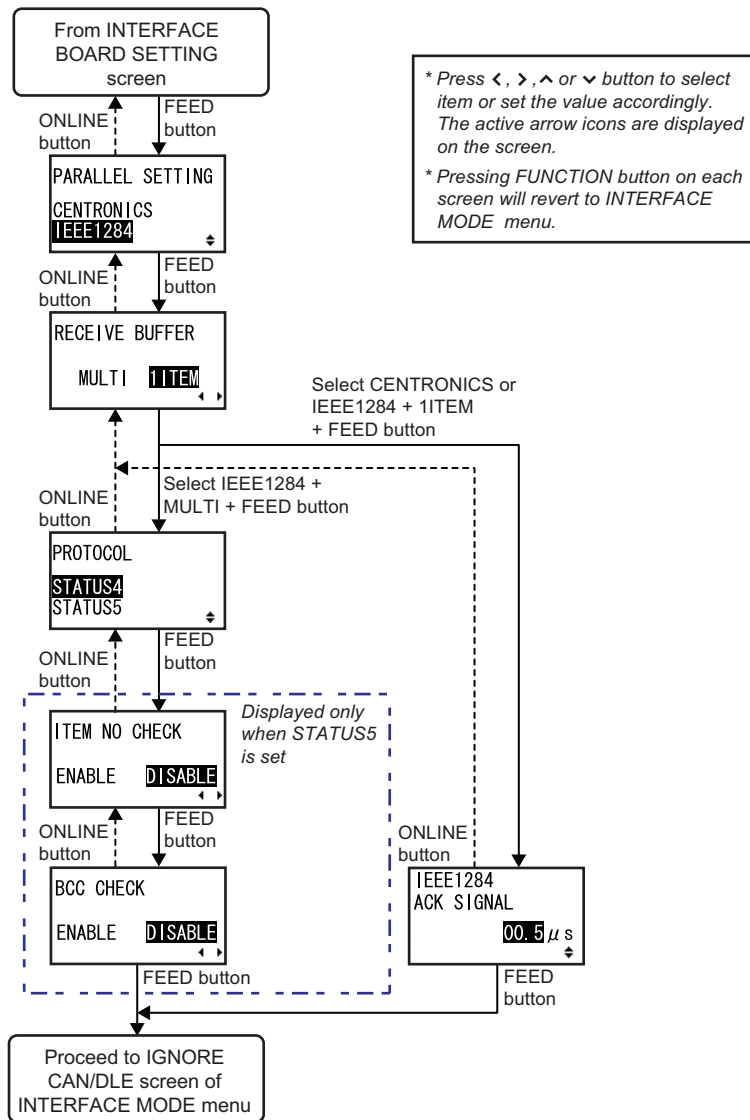

3.7 INTERFACE MODE (Cont'd)

Setting of IEEE1284

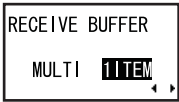
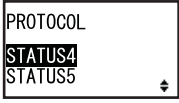
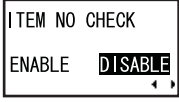

IEEE1284 CONFIGURATION	
Menu	Description
	<p>Setting the motion of SELECT IN signal for IEEE1284.</p> <p>CENTRONICS: SELECT IN signal (36-pin) becomes LO (low) constantly</p> <p>IEEE1284: Motion based on the IEEE1284 standards will be taken (Becomes LO for Compatible Mode, HI for other modes)</p> <p>The initial value is IEEE1284.</p> <p>Note: As for the use of PC98, a communication failure occurred when SELECT IN signal remained HI in the SR series printers. This additional setting is to eliminate the communication failure.</p>

3.7 INTERFACE MODE (Cont'd)

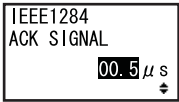
IEEE1284 CONFIGURATION	
Menu	Description
	<p>Setting receive buffer type.</p> <p>When MULTI and IEEE1284 are selected, the printer will proceed to PROTOCOL menu.</p> <p>When 1ITEM and IEEE1284 or CENTRONICS are selected, the printer will proceed to IEEE1284 ACK SIGNAL menu.</p> <p>The initial value is 1ITEM.</p>
	<p>Select the communication protocol.</p> <p>STATUS4 and STATUS5 are available for selection when IEEE1284 interface boards is installed.</p> <p>The initial value is STATUS4.</p> <p>When STATUS4 is selected, the printer will proceed directly to IGNORE CR/LF menu.</p> <p>When STATUS5 is selected, the printer will proceed to ITEM NO CHECK menu.</p>
	<p>Set item number check function.</p> <p>ENABLE: Item number check is ON</p> <p>DISABLE: Item number check is OFF</p> <p>The initial value is DISABLE.</p> <p>This screen is displayed only when PROTOCOL is set to STATUS5.</p>
	<p>Set BCC check function.</p> <p>ENABLE: BCC check is ON</p> <p>DISABLE: BCC check is OFF</p> <p>The initial value is DISABLE.</p> <p>This screen is displayed only when PROTOCOL is set to STATUS5.</p>
	<p>Set the IEEE1284 ACK signal.</p> <p>Press ^/∇ arrow buttons to change the setting value.</p> <p>Setting range is between 00.5μs and 12.0μs, and settable by 0.1μs.</p> <p>The initial value is 00.5μs.</p> <p>This screen is displayed only when RECEIVE BUFFER is set to 1ITEM.</p>

3.7 INTERFACE MODE (Cont'd)

Setting of USB

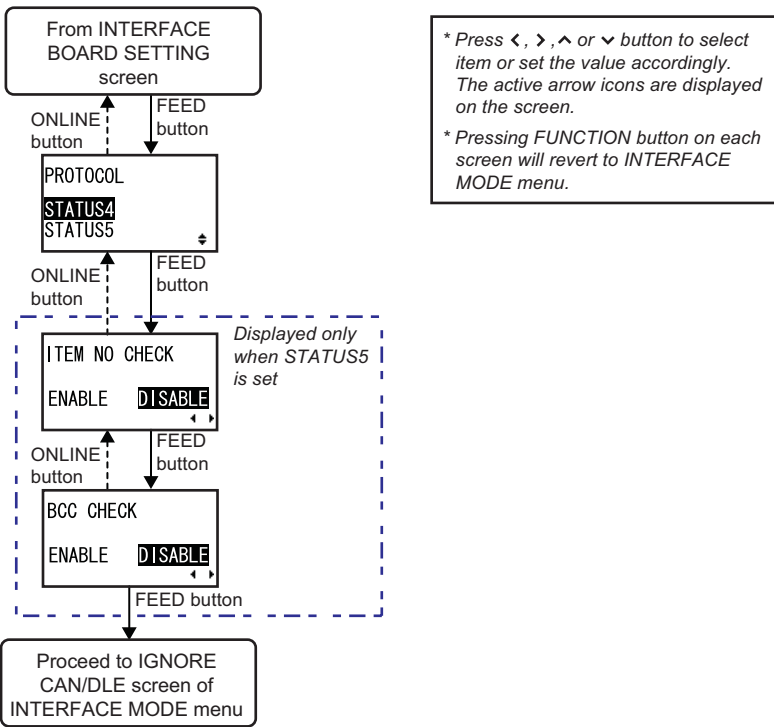



USB CONFIGURATION	
Menu	Description
	Select the communication protocol. STATUS4 and STATUS5 are available for selection when USB interface boards is installed. The initial value is STATUS4. When STATUS4 is selected, the printer will proceed directly to IGNORE CR/LF menu. When STATUS5 is selected, the printer will proceed to ITEM NO CHECK menu.
	Set item number check function. ENABLE: Item number check is ON DISABLE: Item number check is OFF The initial value is DISABLE. This screen is displayed only when PROTOCOL is set to STATUS5.
	Set BCC check function. ENABLE: BCC check is ON DISABLE: BCC check is OFF The initial value is DISABLE. This screen is displayed only when PROTOCOL is set to STATUS5.

3.7 INTERFACE MODE (Cont'd)

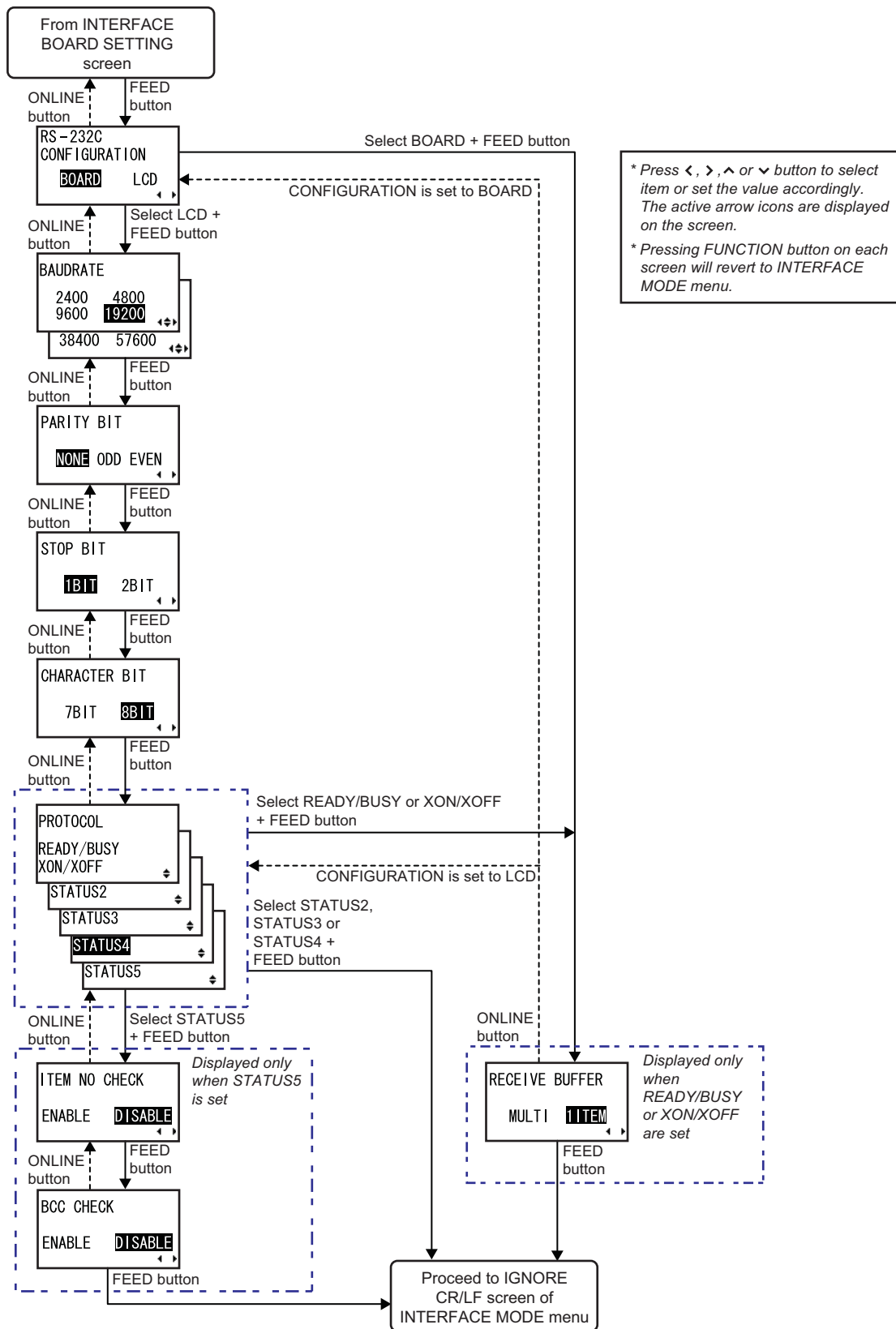
Setting of RS-232C

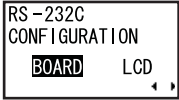
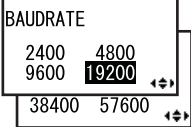

3.7 INTERFACE MODE (Cont'd)

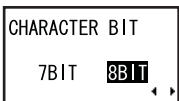
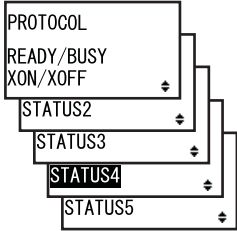
RS-232C CONFIGURATION	
Menu	Description
	<p>This screen allows user to select the RS-232C configurations based on either the setting on interface board (DIP switch) or the setting of LCD.</p> <p>BOARD: Priority on current interface board settings. Select BOARD and press FEED button will proceed directly to RECEIVE BUFFER or IGNORE CR/LF screen.</p> <p>LCD: Priority on LCD settings. Select LCD and press FEED button will continue to BAUDRATE setting. The initial cursor position is at BOARD.</p> <p>Note: Changed settings will be in effect from the next power on.</p>
	<p>Setting RS-232C baud rate. Press arrow buttons to set the baudrate as 2400, 4800, 9600, 19200, 38300, or 57600. Press FEED button to save the setting. The initial value is 19200.</p> <p>Note: Changed settings will be in effect from the next power on.</p>
	<p>Setting RS-232C parity bit. The initial value is NONE.</p> <p>Note: Changed settings will be in effect from the next power on.</p>
	<p>Setting RS-232C stop bit. The initial value is 1BIT.</p> <p>Note: Changed settings will be in effect from the next power on.</p>
	<p>Setting RS-232C character bit. The initial value is 8BIT.</p> <p>Note: Changed settings will be in effect from the next power on.</p>
	<p>Setting communication protocol. The following protocols are available when RS-232C interface board is installed.</p> <ol style="list-style-type: none"> 1) READY/BUSY 2) XON/OFF 3) STATUS2 4) STATUS3 5) STATUS4 6) STATUS5 <p>The initial value is STATUS4.</p> <p>When READY/BUSY or XON/XOFF is selected, the printer will proceed directly to RECEIVE BUFFER menu.</p> <p>When STATUS5 is selected, the printer will proceed directly to ITEM NO CHECK menu.</p> <p>When STATUS2, STATUS3 or STATUS4 is selected, the printer will proceed directly to IGNORE CR/LF menu.</p> <p>Note: Changed settings will be in effect from the next power on</p>

3.7 INTERFACE MODE (Cont'd)

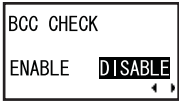
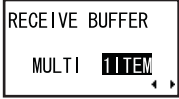
RS-232C CONFIGURATION	
Menu	Description
	Set item number check function. ENABLE: Item number check is ON DISABLE: Item number check is OFF The initial value is DISABLE. This screen is displayed only when PROTOCOL is set to STATUS5.
	Set BCC check function. ENABLE: BCC check is ON DISABLE: BCC check is OFF The initial value is DISABLE. This screen is displayed only when PROTOCOL is set to STATUS5.
	Setting receive buffer type. This screen is displayed only when PROTOCOL is set to READY/BUSY or XON/XOFF. The initial value is 1ITEM.

3.8 SEMBL MODE

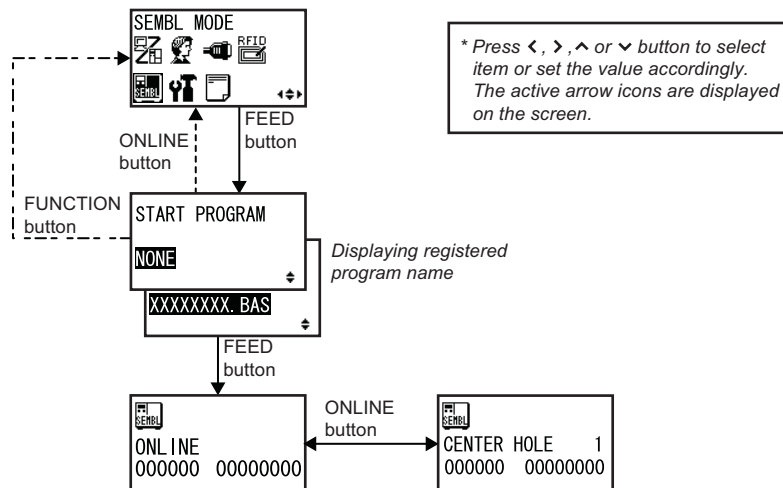

1. During Offline mode, press **FUNCTION** button to display the operational icon menu. Press **arrow** buttons to select SEMBL MODE.
2. When SEMBL MODE is displayed, press the **FEED** button to activate the SEMBL operation.
3. START PROGRAM is first displayed. Press the **arrow** buttons to specify the start-up program.
NONE: Not specifying start-up program
XXXXXXXX.BAS: Specifying startup program
 Program names stored in the main memory will appear in XXXXXXXX.BAS.
 The initial value is NONE.

3.9 ADVANCED MODE

Advanced Mode lets you configure the more advanced features of the printer hardware.

Overview of Advanced Mode configurations

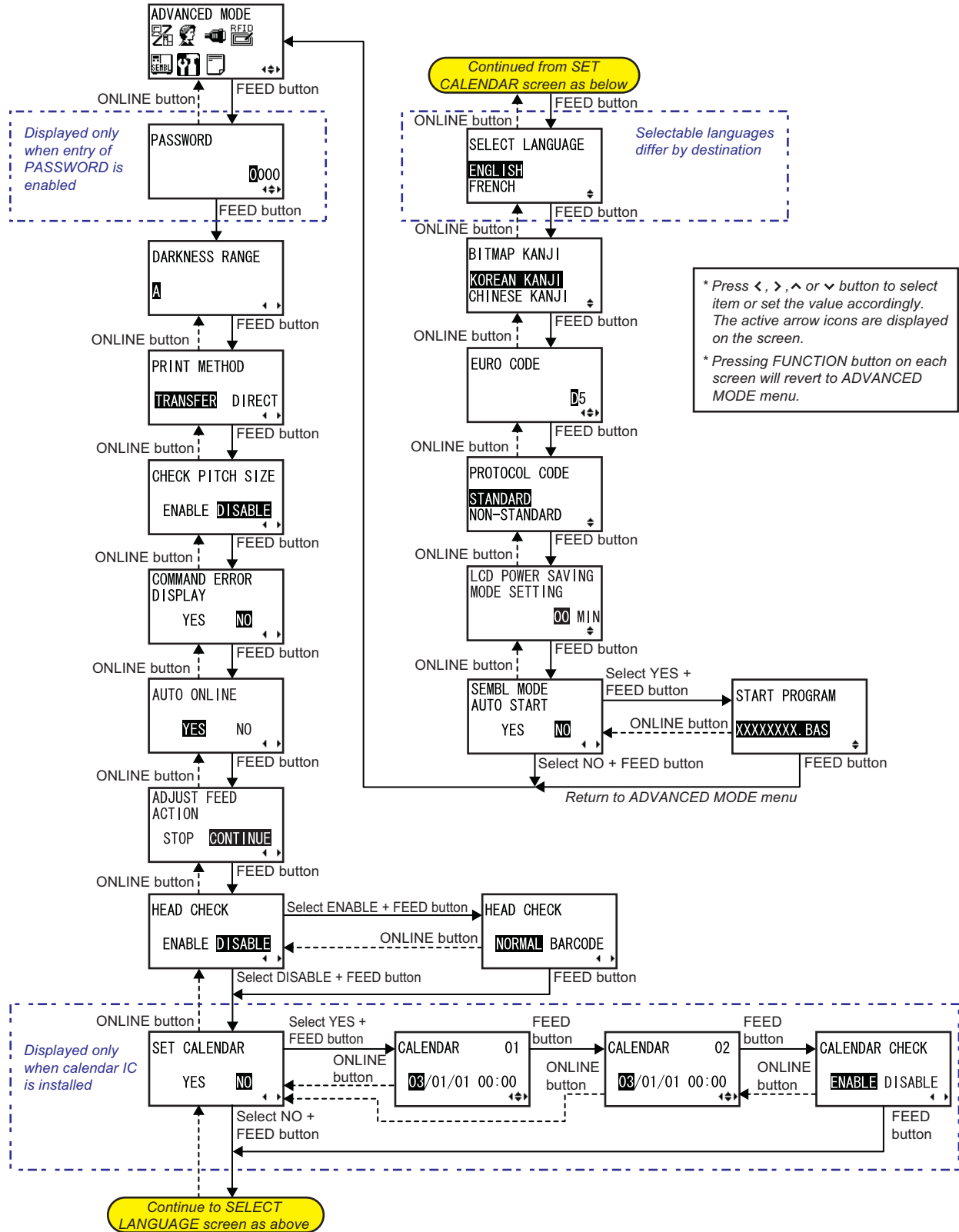



3.9 ADVANCED MODE (Cont'd)

1. During Offline mode, press **FUNCTION** button to display the operational icon menu. Press **arrow** buttons to select ADVANCE MODE.
2. When ADVANCE MODE is displayed, press the **FEED** button to enter to Advance mode for adjustment.



Note:

PASSWORD may prompt on the display if SET PASSWORD is set to ON in the Service mode. Please refer to **Section 3.15 Service Mode** for details in password inputting.

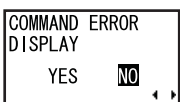
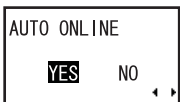

3. DARKNESS RANGE is first displayed. Press the **FEED** button repeatedly will switch to the next setting options as shown above. To return to the previous setting option, press **ONLINE** button.
4. When the desired setting option is displayed, press **arrow** buttons to select the item or to set the value and then press **FEED** button to save the setting.

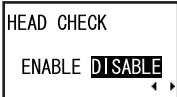
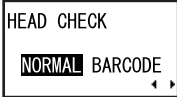
ADVANCED MODE	
Menu	Description
	Setting print darkness range. Available options are from A to F, with F being the darkest density. Only supported range is displayed. The initial setting is at A. Note: Adjustment of this setting is usually unnecessary.
	Setting print method to thermal transfer or direct thermal. TRANSFER: Thermal transfer DIRECT: Direct thermal The initial value is TRANSFER.
	The printer can perform the pitch size check of the loaded media if the A1 command, which fixed the size of the media, is sent to the printer. If the printer detected the media size has fall out of the range of ± 2.5mm (0.1") from the set pitch size, MEDIA ERROR will be displayed. ENABLE: Paper size check is ON DISABLE: Paper size check is OFF The initial value is DISABLE.
	Enabling/ Disabling the display of command error. This setting determines the printer motion when detecting a command error. YES: Stops printing operation when command error is occurred. NO: Displays a warning icon and continues printing operation. The initial value is NO.
	The printer can be set to go into ONLINE mode automatically after feeding the media automatically. Otherwise, the printer starts in the OFFLINE state. YES: The printer goes online after feeding the paper automatically. NO: The printer goes offline after feeding the paper automatically. The initial value is YES.

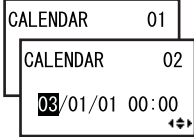
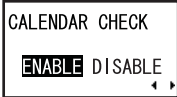
3.9 ADVANCED MODE (Cont'd)

ADVANCED MODE	
Menu	Description
	<p>Specifying the printer motion right after changing the reference position by the <#> command.</p> <p>STOP: Pauses printing operation after changing the reference position.</p> <p>CONTINUE: Continues printing operation after changing the reference position.</p> <p>The initial value is CONTINUE.</p> <p>* This setting is enabled only when paper type is set to tag and the cutter is ON.</p>
	<p>The printer can be set to perform a check of the print head when printing each label.</p> <p>ENABLE: Head check is ON Select ENABLE and press FEED button will proceed to HEAD CHECK menu.</p> <p>DISABLE: Head check is OFF Select DISABLE and press FEED button will proceed directly to SET CALENDAR menu (if calendar IC is installed) or SELECT LANGUAGE menu.</p> <p>The initial value is DISABLE.</p>
	<p>If Head Check has been ENABLE, you can specify the print head checking to be performed unconditionally, or only when barcodes are being printed.</p> <p>NORMAL: Head check is performed on the entire print head.</p> <p>BARCODE: Head check is performed only on position where barcodes are being printed.</p> <p>The initial value is NORMAL.</p> <p>This screen is displayed only when HEAD CHECK is set to ENABLE.</p>
	<p>Selecting the calendar setting.</p> <p>YES: The printer enters date and time setting mode.</p> <p>NO: Skip this setting and proceed to the SELECT LANGUAGE menu.</p> <p>The initial value is NO.</p> <p>This screen is displayed only when calendar IC is installed.</p>
	<p>Set the Year/Month/Date and then set the time in 24 hour format. The highlighted cursor indicates the digit is active for adjustment.</p> <p>Press ^/v arrow buttons to change the setting value and press </> arrow buttons to move the cursor to next digit. Press FEED button to enter the setting.</p> <p>Enter the date and time twice. When the entered value of both screens match, it goes to the next screen after saving the value. If not, the printer beeps and goes back to the first entry display. The number of entries is indicated on the right side of display.</p> <p>This screen is displayed only when YES was selected in SET CALENDAR.</p>
	<p>Enabling/Disabling the calendar check function.</p> <p>ENABLE: Calendar check is ON</p> <p>DISABLE: Calendar check is OFF</p> <p>The initial value is ENABLE.</p> <p>This screen is displayed only when YES was selected in SET CALENDAR.</p>

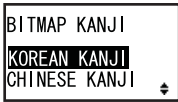
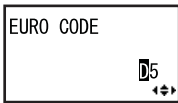
3.9 ADVANCED MODE (Cont'd)

ADVANCED MODE											
Menu	Description										
	<p>Setting the display language on LCD. The display language differs by location that the printer was purchased.</p> <table border="1" style="margin-left: auto; margin-right: auto;"> <thead> <tr> <th>Destination</th> <th>Display language</th> </tr> </thead> <tbody> <tr> <td>US (EX1)</td> <td>English only</td> </tr> <tr> <td>Europe (EX2)</td> <td>French, German, Spanish, Italian, Portuguese or English</td> </tr> <tr> <td>China (EX4)</td> <td>English only</td> </tr> <tr> <td>Korea (EX6)</td> <td>Korean or English</td> </tr> </tbody> </table> <p>The initial value is ENGLISH. If the purchased destination is in China (EX4) or Korea (EX6), BITMAP KANJI menu will display after FEED button is pressed. If the purchased destination is in US (EX1) or Europe (EX2), EURO CODE menu will display after FEED button is pressed.</p>	Destination	Display language	US (EX1)	English only	Europe (EX2)	French, German, Spanish, Italian, Portuguese or English	China (EX4)	English only	Korea (EX6)	Korean or English
Destination	Display language										
US (EX1)	English only										
Europe (EX2)	French, German, Spanish, Italian, Portuguese or English										
China (EX4)	English only										
Korea (EX6)	Korean or English										
	<p>Selecting Bitmap Kanji. The available Kanji differs by destination.</p> <table border="1" style="margin-left: auto; margin-right: auto;"> <thead> <tr> <th>Destination</th> <th>Display language</th> </tr> </thead> <tbody> <tr> <td>China</td> <td>Japanese or Chinese*</td> </tr> <tr> <td>Korea (EX6)</td> <td>Chinese or Korean*</td> </tr> </tbody> </table> <p>Display language indicated by "*" is the initial selection.</p>	Destination	Display language	China	Japanese or Chinese*	Korea (EX6)	Chinese or Korean*				
Destination	Display language										
China	Japanese or Chinese*										
Korea (EX6)	Chinese or Korean*										
	<p>This menu lets you select the symbol for representing the Euro mark (currency symbol). The initial value is D5.</p>										
	<p>The ESC sequence in SBPL commands can be defined as standard (using non-printable code 1BH) or non-standard (some other user code). The initial value is STANDARD. To set non-standard code, send the user download command <LD> in Normal Mode. For more details on the <LD> command, refer to the Command Specifications.</p>										

3.9 ADVANCED MODE (Cont'd)

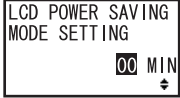
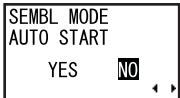
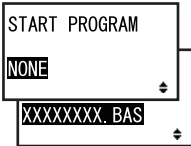
ADVANCED MODE	
Menu	Description
 <p>LCD POWER SAVING MODE SETTING 00 MIN</p>	<p>LCD backlight is turned off for power saving when the printer is not operated for a specified period of time. Set the time between 00 and 15 MIN. This power saving function is disabled when it is 00 MIN, and the LCD backlight will be on constantly. The initial value is 00 MIN.</p>
 <p>SEMBL MODE AUTO START YES NO</p>	<p>This setting determines if the printer enters SEMBL mode automatically on being turned ON. YES: Starting up SEMBL Mode at the time of power-on. NO: Normal start up. The initial value is NO.</p>
 <p>START PROGRAM NONE XXXXXXXXX.BAS</p>	<p>Selecting the program to be executed when starting SEMBL Mode automatically. NONE: Not specifying start -up program XXXXXXXXX.BAS: Specifying startup program Program names stored in the main memory will appear in XXXXXXXX.BAS. The initial value is NONE. This screen is displayed only when SEMBL MODE AUTO START is enabled.</p>

More about the Head Check function

- The head check function detects the integrity of the heating elements in the thermal print head. However, malfunctions cannot be detected instantaneously—a few printed labels may start showing printing defects before the printer warns of a print head error.
- After detection of a print head error, use a scanner to check all affected labels.
- When a head check error occurs during normal printing (barcodes, text and graphics), press and hold down the **FEED** button for five seconds. At the next screen, select BARCODE, then press **FEED** button and see if printing can be resumed normally. If printing resume, the print head faulty does not fall on the barcode area for the current print job. As such, printing may be continue but with degraded print quality and readable barcode.
If the head check error still occurs and the current print job has to be complete, the printing can be forced to resume by holding down the **LINE** and **FEED** buttons for five seconds. Please read the Attention below before you proceed this operation.

ATTENTION:

Although restricting the head check type to BARCODE allows you to continue printing, or forcing the printer to resume printing, you should only do so in order to complete an urgent print job. Check the printed labels to make sure the output is usable in spite of the head error. As soon as possible, stop using the print head to prevent further damage. If necessary, get the print head replaced.

3.10 HEX DUMP MODE

HEX Dump Mode allows you to print the contents of the receive buffer in a hexadecimal format to allow the data stream to be examined for errors and troubleshooting.

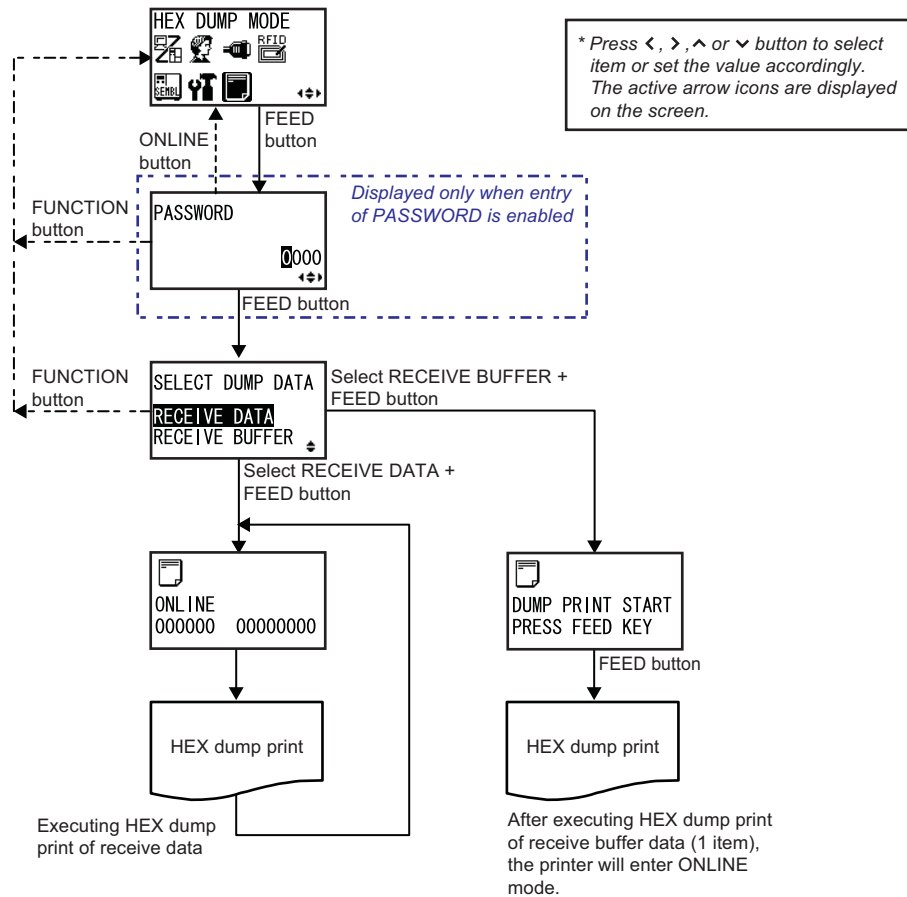

When HEX DUMP MODE is displayed, press the **FEED** button to enter to HEX Dump mode.

Note:

PASSWORD may prompt on the display if SET PASSWORD is set to ON in the Service mode. Please refer to **Section 3.15 Service Mode** for details in password inputting.

HEX DUMP MODE	
Menu	Description
	<p>You can choose to dump either incoming data (RECEIVE DATA) or print data already stored in the buffer (RECEIVE BUFFER). The initial value is RECEIVE DATA. Note that RECEIVE BUFFER cannot be selected when there is no received data.</p> <p>During HEX Dump Mode, the icon is displayed in the ONLINE screen.</p>

3.11 RFID USER MODE

RFID User Mode lets you configure the RFID reading and writing features and as well as performing the test.

Overview of RFID User Mode configurations

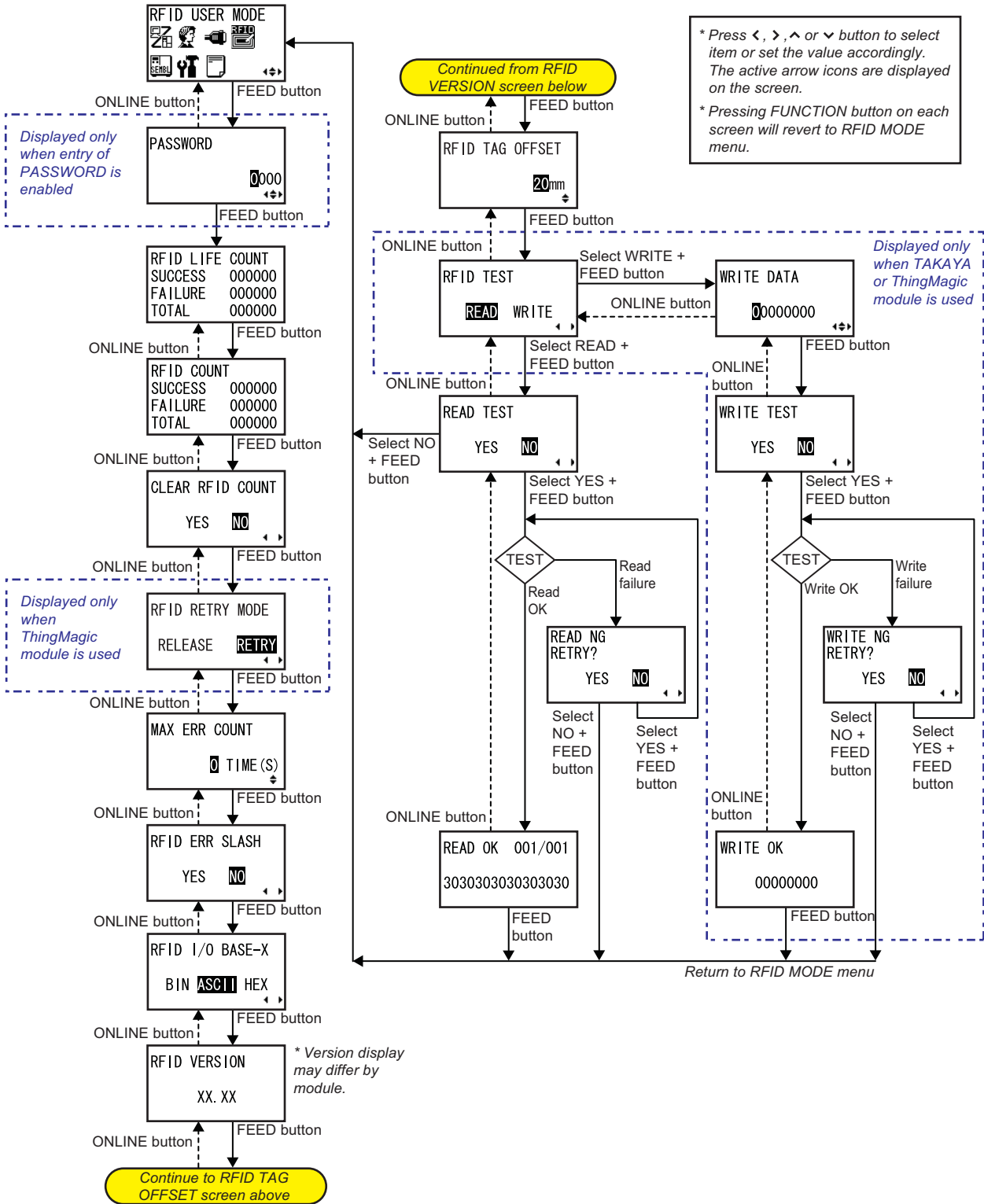

3.11 RFID USER MODE (Cont'd)

1. During Offline mode, press **FUNCTION** button to display the operational icon menu. Press **arrow** buttons to select the RFID USER MODE.



The RFID USER MODE icon is displayed only when the RFID MODULE was ENABLE in the Maintenance mode. Please refer to **Section 3.16 RFID Mode** for details.

2. When RFID MODE is displayed, press the **FEED** button to enter to RFID mode for adjustment.

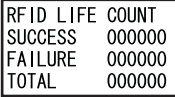
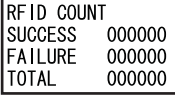
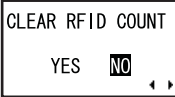

Note:

PASSWORD may prompt on the display if SET PASSWORD is set to ON in the Service mode. Please refer to **Section 3.15 Service Mode** for details in password inputting.

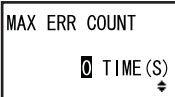
3. RFID LIFE COUNT is first displayed. Press the **FEED** button repeatedly will switch to the next setting options as shown above. To return to the previous setting option, press **ONLINE** button.
4. When the desired setting option is displayed, press **arrow** buttons to select the item or to set the value and then press **FEED** button to save the setting.

RFID USER MODE	
Menu	Description
	<p>Showing the total number of RFID write after factory clear. SUCCESS: Shows the number of write success to RFID tag. FAILURE: Shows the number of write failure to RFID tag. TOTAL: Shows the total print quantity. This counter can be reset by factory clear only</p>
	<p>Showing the total number of RFID writes. SUCCESS: Shows the number of write success to RFID tag. FAILURE: Shows the number of write failure to RFID tag. TOTAL: Shows the total number of writes.</p>
	<p>Initializing RFID current counter. Selecting YES and pressing FEED button will initialize the RFID current counter. The initial value is NO. RFID life counter cannot be reset through this screen.</p>
	<p>Setting the printer motion at the time of RFID tag error. Also, this section shows how to recover from an RFID ERROR state when the error count exceeds the specified limit. RELEASE: The printer keeps writing tags and discarding defective tags up to a specified quantity even when a tag error occurs. Then the printer emits a RFID ERROR message and pauses the operation when the error count exceeds the specified limit. RETRY: When a tag error occurs, the printer attempts to write the same data based on the specified quantity. If the tag writing still fails, the printer emits a RFID ERROR message and pauses the operation. The initial value is RETRY. This screen is displayed only when MODULE SELECT is set to ThingMagic in the Service Mode.</p>
	<p>Setting the counter for void and reprint tags at the time of tag error. Input range is from 0 to 9. The initial value is 0.</p>

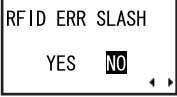
3.11 RFID USER MODE (Cont'd)

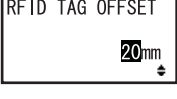
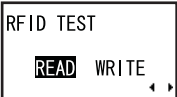
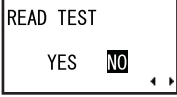
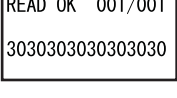
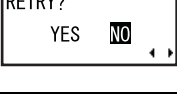
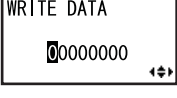
RFID USER MODE	
Menu	Description
	Printing a slash on a tag when an RFID tag error occurred. YES: Prints a slash at the time of RFID tag error. NO: Not printing a slash at the time of RFID tag error. The initial value is NO.
	Setting output format. BIN: Binary format. ASCII: ASCII format. HEX: HEX format. The initial value is ASCII
	Showing RFID module version. Version display may differ by the module to be connected.
	Setting the RFID tag position from the top of form. The input range is between 20 and 240mm. The initial value is 20mm.
	Performing RFID tag read or write test. READ: Start read test. READ TEST menu is displayed when selected. WRITE: Start write test. WRITE DATA menu is displayed when selected. The initial value is READ. This screen appears only when TAKAYA or ThingMagic is set to MODULE SELECT in the Service Mode.
	Performing RFID tag read test. Select YES and press FEED button to proceed the RFID reading test. The initial value is NO.
	Showing the data read from RFID tag. Press ^ / v arrow buttons to switch between pages. This message appears when RFID tag is read successfully. Press FEED button to exit from this screen.
	This message appears when failing to read RFID tag. Select YES and press FEED button to repeat the RFID reading test. If NO is selected, printer goes to ONLINE mode. The initial value is NO.
	Entering test data to be written to RFID tag. Press ^ / v arrow buttons to key in the test data and press </> arrow buttons to move the cursor to next digit. Press FEED button to enter the setting. The initial value is 00000000. This screen appears only when TAKAYA or ThingMagic is set to MODULE SELECT in the Service Mode.

3.11 RFID USER MODE (Cont'd)

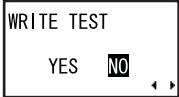
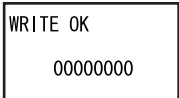
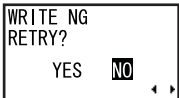
RFID USER MODE	
Menu	Description
	<p>Performing write test to RFID tag. Select YES and press FEED button to proceed the RFID tag writing test. If NO is selected, the printer goes to RFID TEST menu. The initial value is NO. This screen appears only when TAKAYA or ThingMagic is set to MODULE SELECT in the Service Mode.</p>
	<p>Showing the data is successfully written on the RFID tag. Press FEED button to exit from this screen. This screen appears only when TAKAYA or ThingMagic is set to MODULE SELECT in the Service Mode.</p>
	<p>This message appears when failing to write on RFID tag. Select YES and press FEED button to repeat the RFID writing test. If NO is selected, printer goes to ONLINE mode. The initial value is NO. This screen appears only when TAKAYA or ThingMagic is set to MODULE SELECT in the Service Mode.</p>

3.12 TEST PRINT MODE

* Press \leftarrow , \rightarrow , \wedge or \vee button to select item or set the value accordingly. The active arrow icons are displayed on the screen.

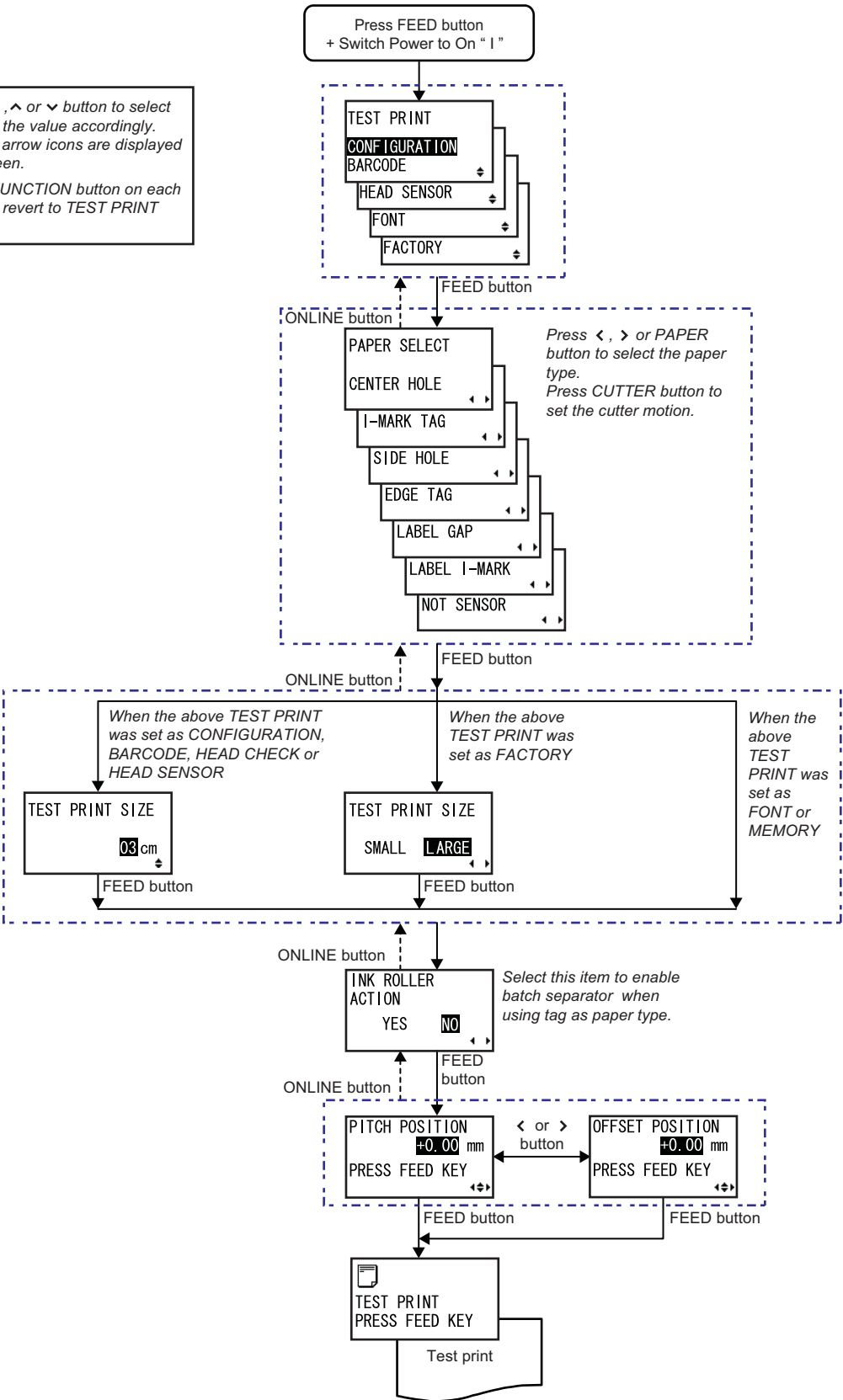

* Pressing FUNCTION button on each screen will revert to TEST PRINT menu.



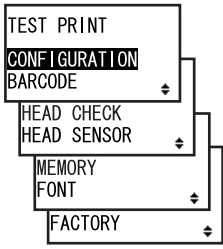
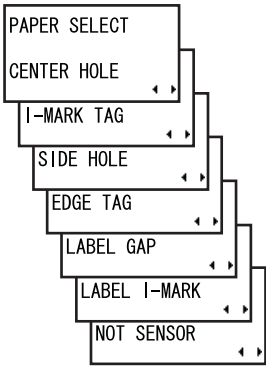

3.12 TEST PRINT MODE (Cont'd)

The Test Print Mode offers seven different printer status labels for troubleshooting.

1. Make sure the Power of the printer is turned off (O).
2. While pressing the **FEED** button, switch the Power to On (I).
3. TEST PRINT is displayed on the screen. Press the **FEED** button repeatedly will switch to the next setting options as shown above. To return to the previous setting option, press **ONLINE** button.
4. When the desired setting option is displayed, press **arrow** buttons to select the item or to set the value and then press **FEED** button to save the setting.

TEST PRINT MODE	
Menu	Description
	<p>Choosing the Test Print Contents.</p> <p>CONFIGURATION: The configuration settings of the printer will be printed. BARCODE: The barcodes installed in this printer will be printed. HEAD CHECK: The head check pattern of the selected media size area will be printed. HEAD SENSOR: The head check pattern and the sensor rating will be printed. MEMORY: The contents of the memory in this printer will be printed. FONT: The contents of the fonts installed in this printer will be printed. FACTORY: The factory test print will be performed.</p> <p>The initial value is CONFIGURATION.</p>
	<p>Selecting paper type for test print.</p> <p>Press </> arrow buttons or PAPER button to select paper type and press FEED button to save the setting.</p> <p>While PAPER SELECT is displayed, pressing the CUTTER button will set the cutter motion.</p> <p>If Font or Memory is selected in the previous menu, after setting the PAPER SELECT, the printer will proceed directly to INK ROLLER ACTION menu without setting the print size.</p>
	<p>If you chose test prints of Configuration, Barcode, Head Check or Head Sensor in the previous menu, this screen lets you choose the width of the test print from 03 to 08 cm, in increments of 1 cm.</p> <p>The initial size is 03cm.</p>
	<p>For Factory test prints, this screen appears instead of the previous screen for setting print size. In this screen, you can choose only to print the test results in LARGE or SMALL print widths.</p> <p>SMALL: Test print in 3cm width LARGE: Test print in 8cm width</p> <p>The initial value is LARGE.</p>

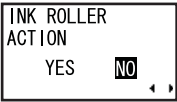
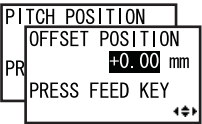
3.12 TEST PRINT MODE (Cont'd)

TEST PRINT MODE	
Menu	Description
	<p>Setting ink roller motion during test print. NO: No ink roller action will be taken. YES: Ink roller action will be taken during test print. The initial value is NO.</p>
	<p>Adjusting the print and cut positions. Press ^/v arrow buttons to change the setting value and press </> arrow buttons to toggle between PITCH POSITION and OFFSET POSITION setting. Both setting range are ±3.75mm and are adjustable by 0.25mm. The initial value is +0.00mm. Press FEED button to start test printing.</p>
	<p>Test print is in progress Press FEED button while printing will pause the test print operation. Press FEED again to continue.</p>

3.13 DEFAULT SETTING MODE

The printer can be reset to the default setting as in the factory preset.

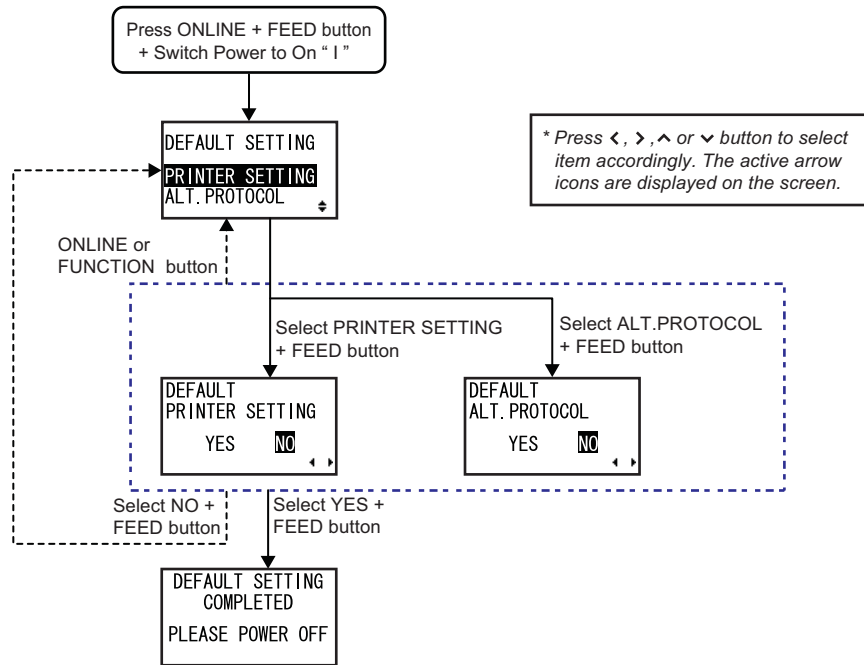

1. Make sure the Power of the printer is turned off (O).
2. While pressing the **ONLINE** button and the **FEED** button simultaneously, switch the Power to On (I).
3. The printer enters DEFAULT SETTING mode.

DEFAULT SETTING MODE	
Menu	Description
	Select the item to be initialized. PRINTER SETTING: Initializing printer setting ALT. PROTOCOL: Initializing protocol code The initial setting is PRINTER SETTING. When PRINTER SETTING is selected, the printer displays the DEFAULT PRINTER SETTING confirmation menu. When ALT. PROTOCOL is selected, the printer displays the DEFAULT ALT. PROTOCOL confirmation menu.
	DEFAULT PRINTER SETTING confirmation menu. Selecting YES and pressing FEED button will initialize the printer setting. The initial value is NO. If NO, it goes to DEFAULT SETTING without initializing the printer setting.
	DEFAULT ALT. PROTOCOL confirmation menu. Selecting YES and pressing FEED button will initialize protocol code. The initial value is NO. If NO, it goes to DEFAULT SETTING without initializing protocol code.

3.13 DEFAULT SETTING MODE (Cont'd)

DEFAULT SETTING MODE	
Menu	Description
<div style="border: 1px solid black; padding: 5px; width: fit-content;"> DEFAULT SETTING COMPLETED PLEASE POWER OFF </div>	This screen shows the completion of initialization and three beeps sound is heard. After this message is shown, power off the printer.

3.13.1 Table of Default Settings

Items	Default value	
	TG308	TG312
ADJUSTMENT MODE		
PITCH POSITION	0	
CUT OFFSET	0	
DARKNESS	50	
USER MODE		
PRINT SPEED	6 INCH	
PRINT DARKNESS	2	
PRINT OFFSET	V:+000 H:+000	
ZERO SLASH	YES	
CHARACTER PITCH	PROPORTIONAL	
INTERFACE MODE		
KEYPAD CONNECT	ENABLE	
RS-232C CONFIGURATION		
Priority on interface board settings		
BAUDRATE	19200bps	
PARITY BIT	NONE	
STOP BIT	1 BIT	
CHARACTER BIT	8 BIT	
LAN2/WIRELESS LAN2 CONFIGURATION		
Priority on interface board settings		
IP ADDRESS	0.0.0.0	
SUBNET MASK	0.0.0.0	
GATEWAY ADDRESS	0.0.0.0	
PORT NUMBER 1	1024	
PORT NUMBER 2	1025	
PORT NUMBER 3	9100	
WIRELESS MODE (WIRELESS LAN)	802.11 Ad Hoc	
SSID (WIRELESS LAN)	(Space)	
CHANNEL (WIRELESS LAN)	01	
IEEE1284 ACK SIGNAL	0.5μs	
PARALLEL SETTING	IEEE1284	
PROTOCOL	STATUS4	
STATUS REPLY TIMING	CYCLE	
RECEIVE BUFFER	1ITEM	
ITEM NO CHECK	DISABLE	
BCC CHECK	DISABLE	
Keypad CONNECT	ENABLE	
RFID USER MODE		
RFID LIFE COUNT	0	
RFID COUNT	0	
MAX ERR COUNT	0	
RFID ERR SLASH	NO	
RFID I/O BASE-X	ASCII	
RFID TAG OFFSET	20mm	

3.13 DEFAULT SETTING MODE (Cont'd)

3.13.1 Table of Default Settings (Cont'd)

Items	Default value	
	TG308	TG312
ADVANCED MOD		
DARKNESS RANGE	A	
PRINT METHOD	TRANSFER	
CHECK PITCH SIZE	DISABLE	
COMMAND ERROR DISPLAY	NO	
AUTO ONLINE	YES	
ADJUST FEED ACTION	CONTINUE	
HEAD CHECK	DISABLE	
CALENDAR CHECK	ENABLE	
SELECT LANGUAGE	ENGLISH	
EURO CODE	D5	
PROTOCOL CODE	STANDARD	
NON-STANDARD	STX=7Bh,ETX=7Dh,ESC=5Eh,ENQ=40h, CAN=21h,NULL=00h,OFFLINE=5Dh	
LCD POWER SAVING MODE SETTING	00 MIN	
SEMBL MODE AUTO START	NO	
SERVICE MODE		
SENSOR LEVEL (I-MARK)	31	
SLICE LEVEL (I-MARK)	AUTO	
SENSOR LEVEL (GAP)	31	
SLICE LEVEL (GAP)	AUTO	
SENSOR LEVEL (SIDE HOLE)	31	
SENSOR LEVEL (EDGE)	31	
PITCH OFFSET	Label gap: -12 Label I-mark: -36 Others: +00	Label gap: -18 Label I-mark: -54 Others: +00
CUT OFFSET	Label I-mark: -24 Others: +00	Label I-mark: -36 Others: +00
BACKFEED OFFSET	+00	
LOADING OFFSET	+00	
PRINT AREA COMPATIBLE	DISABLE	
PRIORITY SETTING	COMMAND	
STACKER/REWINDER FULL	ENABLE	
PASSWORD NO.	OFF	
NONLOCK CHECK	ENABLE	
FACTORY MODE		
LIFE COUNTER	0	
HEAD COUNTER	0	
CUT COUNTER	0	
RFID MODE		
RFID MODULE	DISABLE	
MODULE SELECT	TAKAYA	

3.14 MAINTENANCE MODE

In Maintenance mode, you can further access to Service mode, Factory mode and RFID mode for more printer configuration.

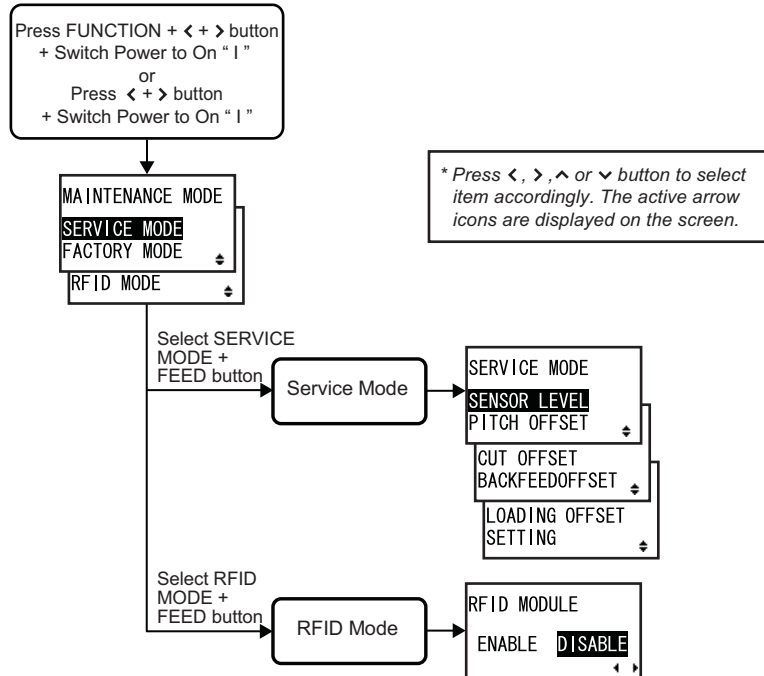

1. Make sure the Power of the printer is turned off (O).
2. While pressing the < and > **arrow** buttons simultaneously, switch the Power to On (I).
The printer enters MAINTENANCE mode.

Note:

You may also access to MAINTENANCE mode by pressing the **FUNCTION** button, < and > **arrow** buttons simultaneously, switch the Power to On (I).

3. Press ^/v **arrow** buttons to select SERVICE MODE or RFID MODE, and then press **FEED** button to enter to the selected mode.

Note:

Please note that FACTORY MODE is strictly for SATO authorised service personnel use. Any mis-adjustment or setting may disrupt the performance of the printer and may cause malfunction.

3.15 SERVICE MODE

In SERVICE MODE menu, you can program various dimensional settings of the printer. Press **▲/▼** arrow buttons to select SERVICE LEVEL, PITCH OFFSET, CUT OFFSET, BACKFEED OFFSET, LOADING OFFSET or SETTING, and then press **FEED** button to enter to the selected mode. Refer to the following flowcharts of the all setting and LCD display menus available in SERVICE MODE.

3.15.1 Overview of Sensor Level adjustment in Service Mode

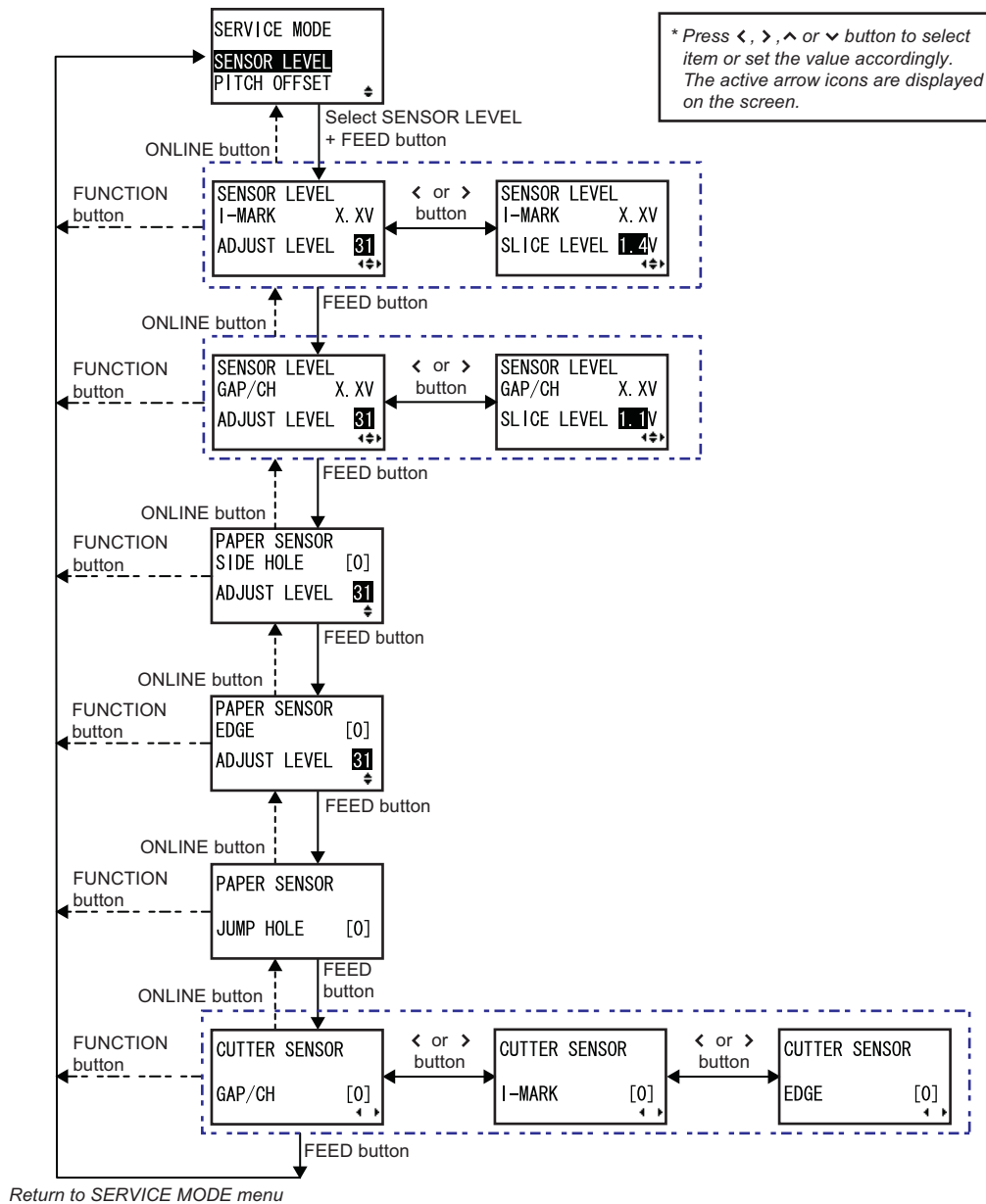

1. When **SENSOR LEVEL** is displayed, press the **FEED** button repeatedly will switch to the next setting options as shown above. To return to the previous setting option, press **ONLINE** button.
2. When the desired setting option is displayed, press **arrow** buttons to select the item or to set the value and then press **FEED** button to save the setting.

3.15 SERVICE MODE (Cont'd)

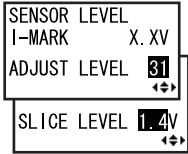
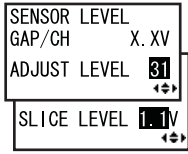
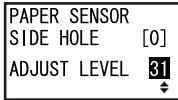
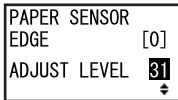
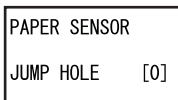
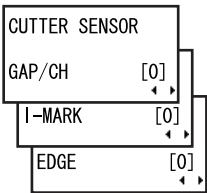
SENSOR LEVEL MODE	
Menu	Description
	<p>Displaying the current level of I-mark sensor on the upper part of the display. Adjust the sensor level offset with \wedge / \vee arrow buttons. This offset determined how soon the sensor responds to an oncoming I-Mark. The adjustment range is between 0 and 63 and is shown on the bottom line of the display. The default setting is 31.</p> <p>Press $<$ / $>$ arrow buttons to save the setting and switch to slice level display. The slice level is calculated automatically and displayed on the bottom line. You can also adjust the slice level by pressing \wedge / \vee arrow buttons. The input range is between 0.0 and 3.2. (adjustable in increments of 0.1)</p> <p>Note: The slice level is automatically set by firmware when the value is set to 0.0. Press FEED button to save the setting and proceed to the next screen.</p>
	<p>Displaying the current level of gap (center hole) sensor on the upper part of the display. Adjust the sensor level offset with \wedge / \vee arrow buttons. This offset determined how soon the sensor responds to an oncoming gap (center hole). The adjustment range is between 0 and 63 and is shown on the bottom line of the display. The default setting is 31.</p> <p>Press $<$ / $>$ arrow buttons to save the setting and switch to slice level display. The slice level is calculated automatically and displayed on the bottom line. You can also adjust the slice level by pressing \wedge / \vee arrow buttons. The input range is between 0.0 and 3.2. (adjustable in increments of 0.1)</p> <p>Note: The slice level is automatically set by firmware when the value is set to 0.0. Press FEED button to save the setting and proceed to the next screen.</p>
	<p>Displaying the current level of side hole sensor. [0] indicates hole detection and [1] indicates tag position. Check the condition of sensor and adjust the sensor level to detect hole correctly. The input range is between 0 and 63. The initial value is 31.</p>
	<p>Displaying the current status of edge sensor. [0] indicates edge detection and [1] indicates tag position. Check the condition of sensor and adjust the sensor level to detect edge of tag correctly. The input range is between 0 and 63. The initial value is 31.</p>
	<p>Displaying the current status of jump hole sensor. [0] indicates hole detection and [1] indicates tag position. This screen only displays status of sensor, as jump hole sensor is adjusted with potentiometer (VR10: J.HOLE) on the Main PCB. Check the condition of jump hole sensor to see if it detects a jump hole properly.</p>
	<p>Displaying the current status of cutter sensor. Switch the type of cutter sensors with $<$ / $>$ arrow buttons. GAP/CH: [0] indicates gap position and [1] indicates tag position. I-MARK: [0] indicates tag position and [1] indicates I-mark position. EDGE: [0] indicates edge position and [1] indicates tag position. Cutter sensor can be adjusted by the volume (potentiometer) on the cutter unit. Therefore, this screen shows sensor state only. Make sure to check and adjust the cutter sensor condition to detect paper properly.</p>

3.15 SERVICE MODE (Cont'd)

3.15.2 Pitch Offset adjustment in Service Mode

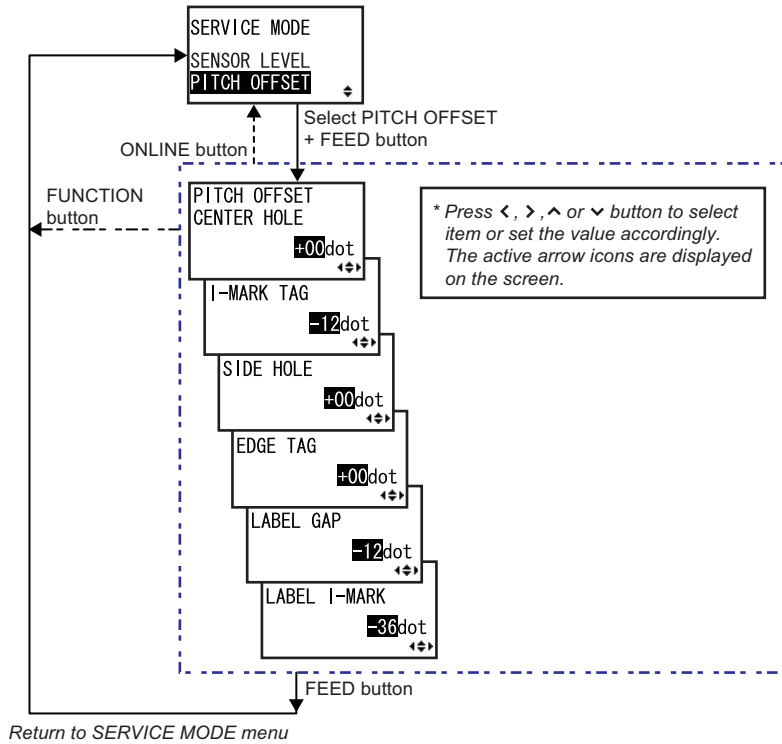

PITCH OFFSET MODE																											
Menu	Description																										
	<p>Adjusting pitch offset for each type of media. Select a media type with < / > arrow buttons. Use ^ / v arrow buttons to enter adjusted value. "+" for moving the pitch position forward. "-" for moving the pitch position backward, against paper feed direction. The adjustment range is between ± 00 and 99 dots. For the initial value of each media and model, refer to the chart below.</p> <table border="1"> <thead> <tr> <th>Media</th> <th>Sensor</th> <th>TG308</th> <th>TG312</th> </tr> </thead> <tbody> <tr> <td rowspan="4">Tag</td> <td>Center hole</td> <td>+00</td> <td>+00</td> </tr> <tr> <td>Side hole</td> <td>+00</td> <td>+00</td> </tr> <tr> <td>Edge</td> <td>+00</td> <td>+00</td> </tr> <tr> <td>I-Mark</td> <td>-12</td> <td>-18</td> </tr> <tr> <td rowspan="2">Label</td> <td>Gap</td> <td>-12</td> <td>-18</td> </tr> <tr> <td>I-Mark</td> <td>-36</td> <td>-54</td> </tr> </tbody> </table>			Media	Sensor	TG308	TG312	Tag	Center hole	+00	+00	Side hole	+00	+00	Edge	+00	+00	I-Mark	-12	-18	Label	Gap	-12	-18	I-Mark	-36	-54
Media	Sensor	TG308	TG312																								
Tag	Center hole	+00	+00																								
	Side hole	+00	+00																								
	Edge	+00	+00																								
	I-Mark	-12	-18																								
Label	Gap	-12	-18																								
	I-Mark	-36	-54																								

3.15 SERVICE MODE (Cont'd)

3.15.3 Cut Offset adjustment in Service Mode

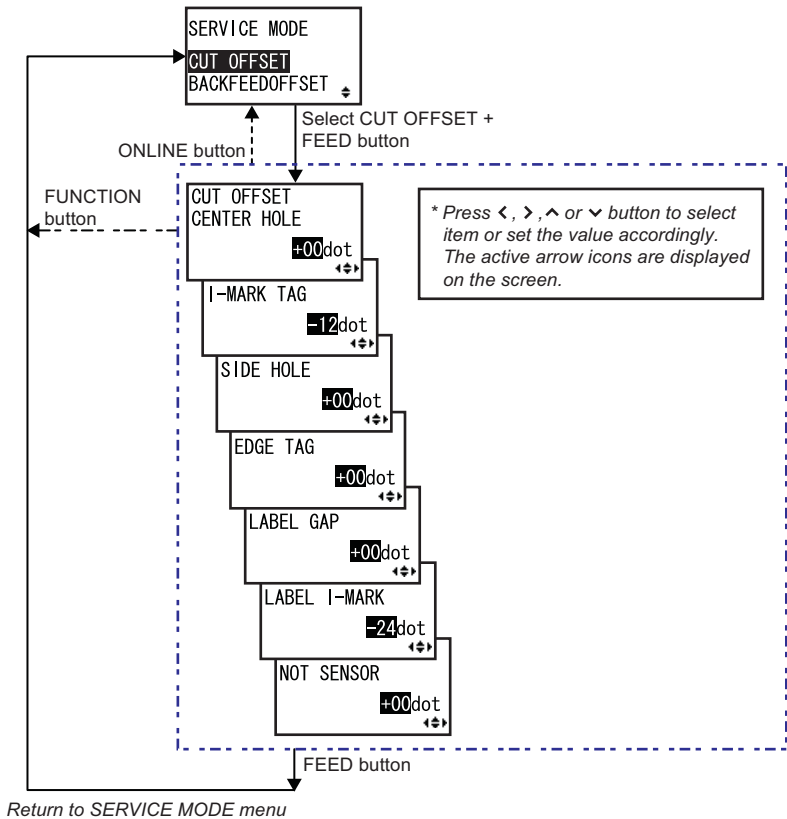

CUT OFFSET MODE																															
Menu	Description																														
	<p>Adjusting cut offset for each type of media. Select a media type with < / > arrow buttons. Use ^ / v arrow buttons to enter adjusted value. "+" for moving the cut position forward. "-" for moving the cut position backward, against paper feed direction. The adjustment range is between ± 00 and 99 dots. For the initial value of each media and model, refer to the chart below.</p>																														
	<table border="1"> <thead> <tr> <th>Media</th> <th>Sensor</th> <th>TG308</th> <th>TG312</th> </tr> </thead> <tbody> <tr> <td rowspan="4">Tag</td> <td>Center hole</td> <td>+00</td> <td>+00</td> </tr> <tr> <td>Side hole</td> <td>+00</td> <td>+00</td> </tr> <tr> <td>Edge</td> <td>+00</td> <td>+00</td> </tr> <tr> <td>I-Mark</td> <td>-12</td> <td>-18</td> </tr> <tr> <td rowspan="2">Label</td> <td>Gap</td> <td>-12</td> <td>-18</td> </tr> <tr> <td>I-Mark</td> <td>-36</td> <td>-54</td> </tr> <tr> <td>Others</td> <td>Not sensor</td> <td>+00</td> <td>+00</td> </tr> </tbody> </table>	Media	Sensor	TG308	TG312	Tag	Center hole	+00	+00	Side hole	+00	+00	Edge	+00	+00	I-Mark	-12	-18	Label	Gap	-12	-18	I-Mark	-36	-54	Others	Not sensor	+00	+00		
Media	Sensor	TG308	TG312																												
Tag	Center hole	+00	+00																												
	Side hole	+00	+00																												
	Edge	+00	+00																												
	I-Mark	-12	-18																												
Label	Gap	-12	-18																												
	I-Mark	-36	-54																												
Others	Not sensor	+00	+00																												

3.15 SERVICE MODE (Cont'd)

3.15.4 Backfeed Offset adjustment in Service Mode

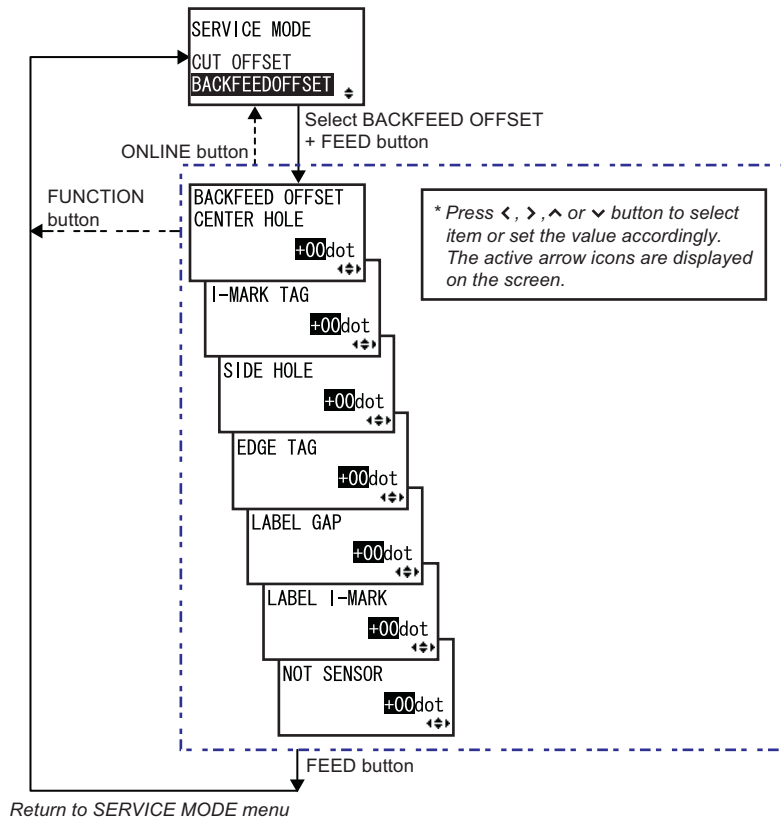

BACKFEED OFFSET MODE	
Menu	Description
	<p>Adjusting backfeed distance for each type of media. Select a media type with < / > arrow buttons. Use ^ / v arrow buttons to enter adjusted value. “+” for moving the print start position (after backfeed) forward. “-” for moving the print start position (after backfeed) backward, against media feed direction. The adjustment range is between ± 00 and 99 dots. The initial value of each media is +00.</p>

3.15 SERVICE MODE (Cont'd)

3.15.5 Loading Offset adjustment in Service Mode

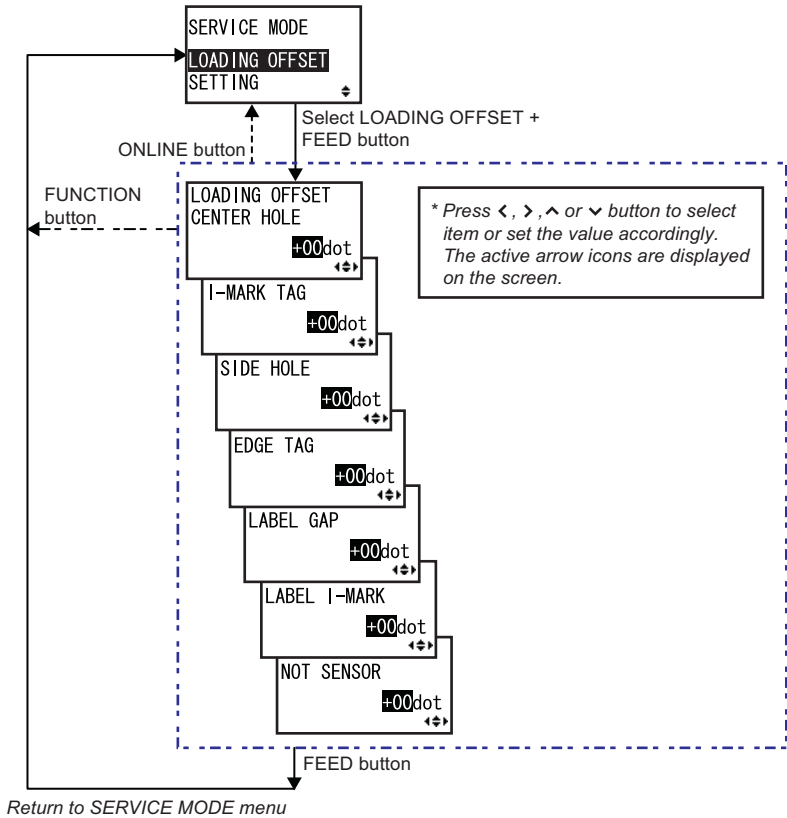

LOADING OFFSET MODE	
Menu	Description
	<p>Adjusting the print start position right after performing automatic feeding function for each type of media.</p> <p>Select a media type with < / > arrow buttons.</p> <p>Use ^ / v arrow buttons to enter adjusted value.</p> <p>“+” for moving the print start position (after auto media feed) forward.</p> <p>“-” for moving the print start position (after auto media feed) backward, against media feed direction.</p> <p>The adjustment range is between ± 00 and 99 dots.</p> <p>The initial value of each media is +00.</p>





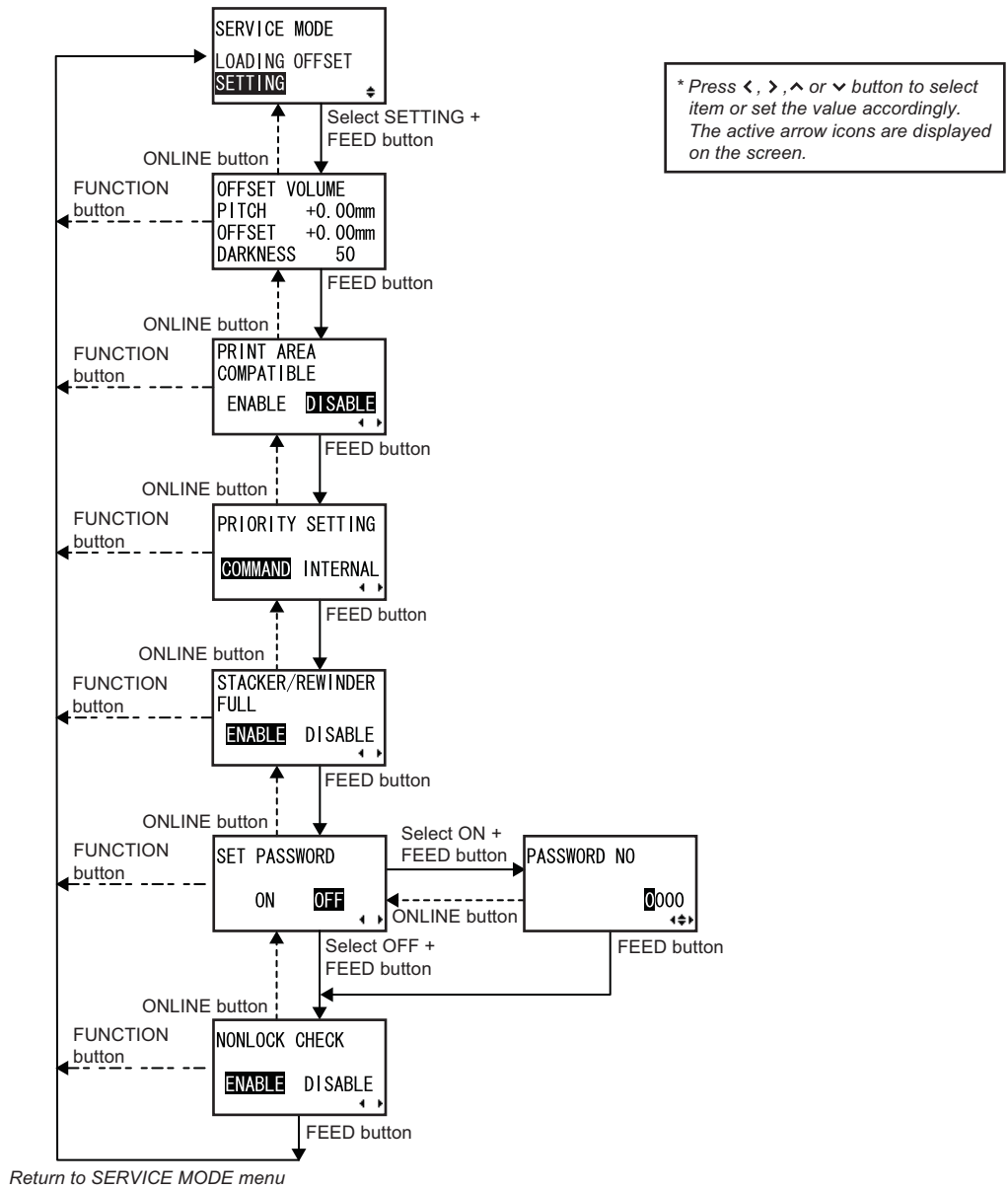

3.15 SERVICE MODE (Cont'd)

3.15.6 Overview of Setting menu in Service Mode

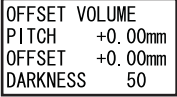

1. When OFFSET VOLUME is displayed, press the **FEED** button repeatedly will switch to the next setting options as shown above. To return to the previous setting option, press **ONLINE** button.
2. When the desired setting option is displayed, press **arrow** buttons to select the item or to set the value and then press **FEED** button to save the setting

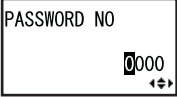
3.15 SERVICE MODE (Cont'd)

SETTING MODE	
Menu	Description
	<p>Displaying the set values of volumes (VR) on the main PCB of the printer.</p> <p>PITCH: Shows the value of print offset volume.</p> <p>OFFSET: Shows the value of cut offset volume.</p> <p>DARKNESS: Shows the value of darkness volume.</p>
	<p>Setting print area.</p> <p>ENABLE: W100mm x H300mm (TG308) W100mm x H240mm (TG312)</p> <p>DISABLE: W80mm x H300mm (TG308) W80mm x H240mm (TG312)</p> <p>The initial value is DISABLE.</p> <p>* This setting provides the compatibility with the print position for existing XL400e/XL410e. This does not mean that the actual print width becomes 100mm. Since an installed print head is 80mm, 20mm on the left side of paper will be blank.</p>
	<p>Enabling/Disabling the command priority for system setting.</p> <p>COMMAND: Priority is given to certain system commands that was sent to the printer and overwrite the configuration done by the LCD operation panel. This priority assignment affects the settings for print darkness, print speed, start point correction, operation mode, printer type, print method and sensor types.</p> <p>INTERNAL: The above mentioned printer configuration set by the LCD operation panel is not replace by the sent command.</p> <p>The initial setting is COMMAND.</p>
	<p>Enabling/Disabling the detection function of stacker/rewinder full.</p> <p>The initial value is ENABLE.</p> <p>*No need to change this setting.</p> <p>This setting is for not detecting an error by lifting the tag hold-down when you use the rewinder connected with a large or small-sized stacker.</p>
	<p>Enabling/Disabling password entry to various modes.</p> <p>ON: To enable password entry.</p> <p>OFF: To disable password entry.</p> <p>The initial value is OFF.</p>
	<p>Setting password to go to various modes.</p> <p>Press ^/v arrow buttons to key in the number and press </> arrow buttons to move the cursor to next digit. Press FEED button to enter the setting.</p>
	<p>Enabling/Disabling the function of nonlock check.</p> <p>ENABLE: Detects ribbon core not lock.</p> <p>DISABLE: No detection of ribbon core not lock.</p> <p>The initial setting is ENABLE.</p>



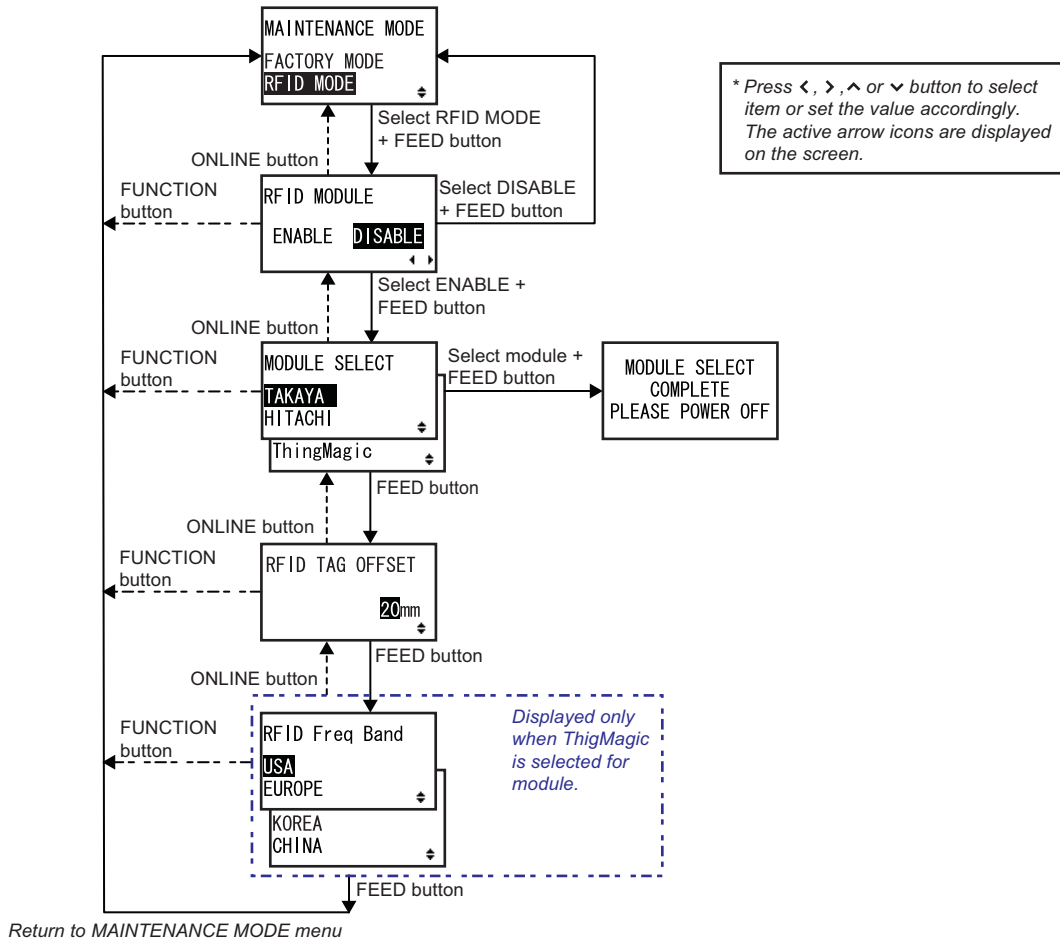

3.16 RFID MODE

After installing the RFID module to the printer, you need to activate the RFID module through the printer configuration.

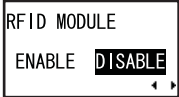

1. When MAINTENANCE MODE is displayed, press **^**/**v** **arrow** buttons and then **FEED** button to enter to RFID MODE.
2. When RFID MODULE is displayed, press **</>** **arrow** buttons to select ENABLE and press the **FEED** button to activate the installed RFID module. Pressing **FEED** button repeatedly will switch to the next setting options as shown above. To return to the previous setting option, press **ONLINE** button.
3. When the desired setting option is displayed, press **arrow** buttons to select the item or to set the value and then press **FEED** button to save the setting

3.16 RFID MODE (Cont'd)

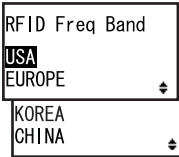
RFID MODE	
Menu	Description
 <p>RFID MODULE ENABLE DISABLE</p>	<p>Setting RFID function.</p> <p>ENABLE: RFID module is activated. RFID USER MODE icon will display on the operational menu when FUNCTION button is pressed in offline mode.</p> <p>DISABLE: RFID function is OFF. The initial value is DISABLE.</p>
 <p>MODULE SELECT TAKAYA HITACHI ThingMagic</p>	<p>Selecting RFID module type.</p> <p>TAKAYA: Setting to TAKAYA module. HITACHI: Setting to HITACHI module. ThingMagic: Setting to ThingMagic module. The initial value is TAKAYA.</p> <p>Notes:</p> <ul style="list-style-type: none"> • If the selected module and the one installed in the printer do not match, the printer will beep six times when it's turned on, and then RFID function will be disabled. • If the RFID module type is changed, the printer saves the selection and goes to MODULE SELECT COMPLETE screen. • If the RFID module type is not changed and just press FEED button, the printer proceed to RFID TAG OFFSET screen.
 <p>MODULE SELECT COMPLETE PLEASE POWER OFF</p>	<p>Indicating that RFID module has been changed. While this message is displayed, the key entry is disabled until power is off.</p>
 <p>RFID TAG OFFSET 20mm</p>	<p>Setting the RFID tag position from the top of form. The input range is between 20 and 240mm. The initial value is 20mm.</p>
 <p>RFID Freq Band USA EUROPE KOREA CHINA</p>	<p>Selecting the RFID frequency band. This screen appears only when the RFID module is set to ThingMagic. Switch the type of cutter sensors with < / > arrow buttons.</p> <p>USA: Setting to the frequency band for U.S. EUROPE: Setting to the frequency band for Europe. KOREA: Setting to the frequency band for Korea. CHINA: Setting to the frequency band for China. THAILAND: Setting to the frequency band for Thailand. The initial selection is USA</p>

3.17 DOWNLOAD MODE

This download feature allows the operator to download data (firmware, font/logo, True type font), from the host computer and write in the Flash ROM memory. When downloading is complete, the LCD screen will return to the original display after three seconds. If an error occurs, a DOWNLOAD DATA ERROR will display and identify the reason.

! CAUTION:



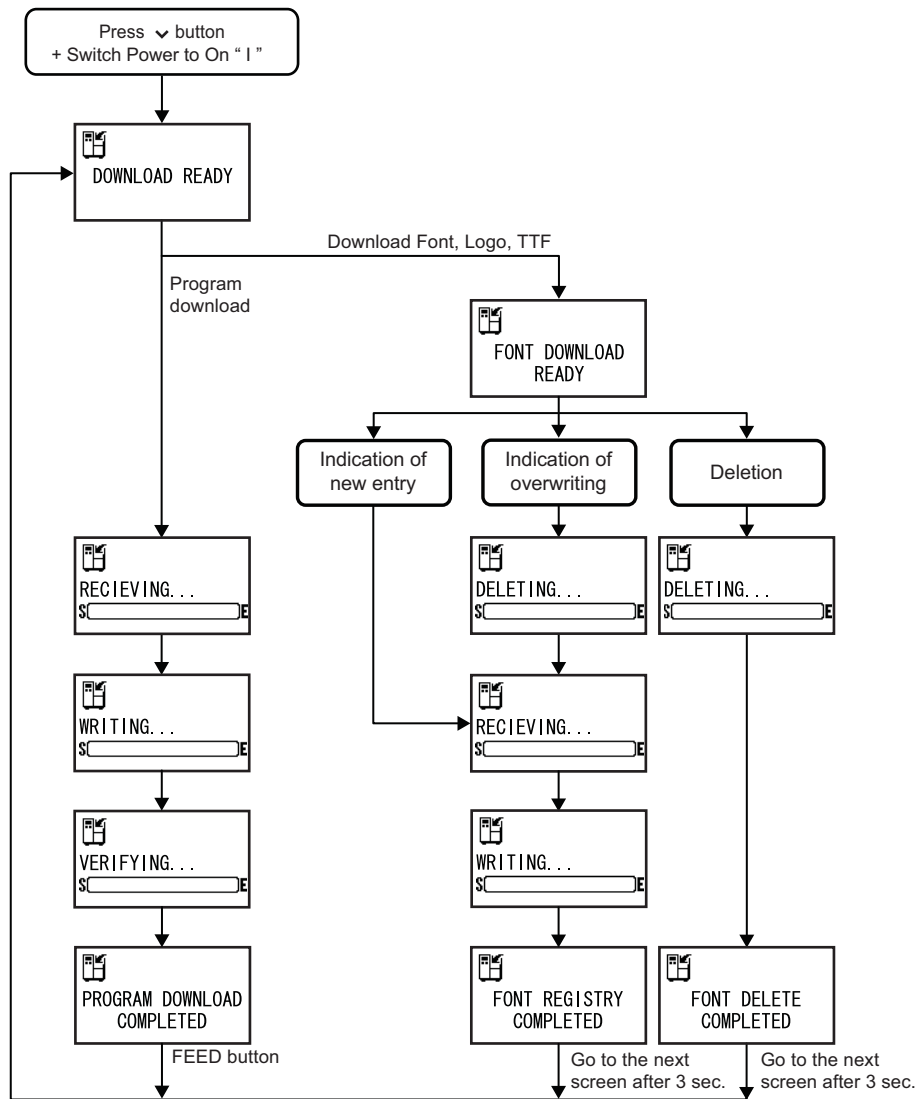

- Downloading firmware will initialize all the previous settings (USER MODE, ADVANCED MODE). Write down its setting details or keep a copy of FACTORY TEST PRINT for your information in case you wish to maintain the same settings in the future.
- Do not turn the power on/off while downloading. This may damage the CONT board (main PCB).



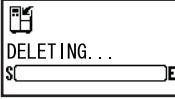
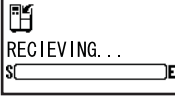
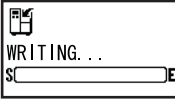
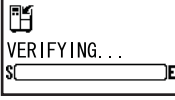

* 3 short beeps sound is heard when the download is completed, or when the fonts are registered or deleted.

3.17 DOWNLOAD MODE (Cont'd)

1. Make sure the Power of the printer is turned off (O).
2. While pressing the **√ arrow** button, switch the Power to On (I).
3. The printer enters DOWNLOAD READY mode.
4. Send in the data for downloading from the host computer to the printer.

DOWNLOAD MODE	
Menu	Description
	<p>Waiting to receive download data. The following data will be received from the PC and written to main ROM.</p> <p>(1) Firmware data (2) Font / Logo data (3) TRUETYPE font</p> <p>When Firmware data is received, it goes to RECEIVING...screen. When Font, Logo and TRUETYPE font are received, it goes to FONT DOWNLOAD READY screen.</p>
	<p>Waiting to receive font data. When downloading the font for the first time, it goes to RECEIVING... screen. To overwrite or delete font data, it goes to DELETING... screen.</p>
	<p>Deleting font data. The gauge shown on the lower portion of screen indicates deleting status of download data. To overwrite font data after deleting the font data, it goes to RECEIVING... screen. To delete the font data, it goes to FONT DELETE COMPLETED screen.</p>
	<p>Receiving download data. The gauge shown on the lower portion of screen indicates downloading status. After receiving the download data, it goes to WRITING... screen.</p>
	<p>Writing download data. The gauge shown on the lower portion of screen indicates writing status of download data. After writing the download data, it goes to FONT REGISTRY COMPLETED screen.</p>
	<p>Verifying download data. The gauge shown on the lower portion of screen indicates verification status of download data. After verifying the download data, it goes to PROGRAM DOWNLOAD COMPLETED screen.</p>
	<p>Completion of download. Emitting three short beeps when program download is completed. Press FEED button to go to DOWNLOAD READY screen.</p>

3.17 DOWNLOAD MODE (Cont'd)

DOWNLOAD MODE	
Menu	Description
 <p>FONT REGISTRY COMPLETED</p>	Completion of font data registry. Emitting three short beeps when font registry is completed. Goes to DOWNLOAD READY screen automatically three seconds later.
 <p>FONT DELETE COMPLETED</p>	Completion of font data deletion. Emitting three short beeps when font delete is completed. Goes to DOWNLOAD READY automatically three seconds later.

4

CLEANING AND MAINTENANCE

This section provides information on user maintenance for the TG3 series printer.

The following information is covered here:

- 4.1 Cleaning The Print Head, Platen and Rollers
- 4.2 How To Clean The Printer (Cleaning Kit)
- 4.3 How To Clean The Printer (Cleaning Sheet)
- 4.4 Adjusting Print Quality



Caution

- When cleaning the print head, bear in mind that the print head and its surroundings may be hot. Wait until the printer cools down before proceeding to clean the printer.
- Be sure to turn off the power before cleaning.
- The suggested cleaning schedules here are just guidelines. If necessary, clean as appropriate, depending on the degree of contamination.
- Use a cleaning pen, cotton swab or cotton cloth, from an approved cleaning kit, to clean the printer units.
- Use only soft, lint-free materials for cleaning. Avoid using hard objects for the cleaning process, as they will damage the components.

4.1 CLEANING THE PRINT HEAD, PLATEN AND ROLLERS

The print head not only generates printouts of barcodes, but also graphics and text. To produce optimal printing, it must be kept clean in spite of the dirt and adhesive that constantly accumulates on its print surface. Furthermore, dirt can accumulate along the label path, affecting parts like sensors and guides, and reducing their performance.

Therefore, it is important to clean these important components periodically. The printer cleaning kit and cleaning sheets can be purchased from your authorized SATO representative.

When to clean with a cleaning kit

- ◆ For the printer head, platen roller, paper sensor, and label guide: clean after using up every other roll of media.
- ◆ For other parts: clean after finishing every six rolls of media.

When to clean with the cleaning sheet

- ◆ For print head: clean after using every six rolls of media, or when you find any burned glaze on the surface of the print head.

4.2 HOW TO CLEAN THE PRINTER (CLEANING KIT)

If you are using a carbon ribbon, be sure to remove it before cleaning. Follow the instructions supplied with the cleaning kit. Use the items to clean the following parts.

1. Before starting, get ready an approved cleaning kit from your SATO representative. Make sure the printer is powered off, and remove the power cable.
2. Lift up the **main cover**.
3. Release the **purple head lock lever** by turning counter clockwise. The **print head** is now accessible.
4. Wipe off the dirt on the **print head**, **platen roller** and **ribbon roller** using a cleaning pen or a cotton swab dabbed with the cleaning liquid. (See figure on the right)
5. Remove the **Pitch sensor guide** by pressing down on the detent latch in the arrow direction. Clean the bottom portion of the **pitch sensor guide**, the media path and the media sensors. Reinstall the Pitch sensor guide by sliding it back on the shaft.

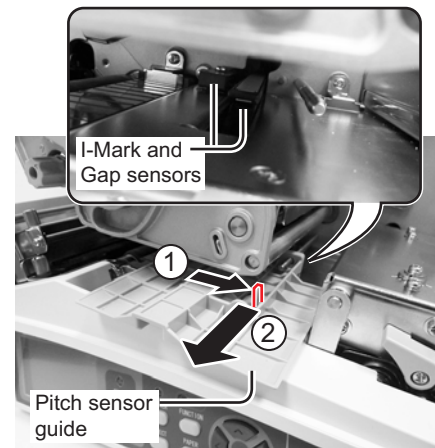
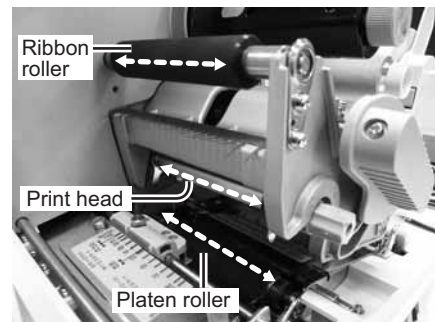

4.2 HOW TO CLEAN THE PRINTER (CLEANING KIT) (Cont'd)

6. Press the purple **Lid Latch lever** to open the hinged **Lid Latch**. Clean the **Nip roller**, **Feed roller**, **Side hole sensor** and **Jump hole sensor**.

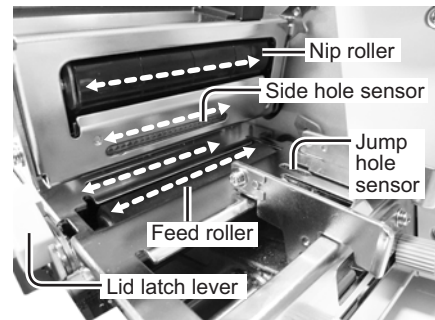

7. Moisten the cotton cloth with cleaning liquid, and use the cloth to wipe any dirt or accumulated adhesive off the **Cutter roller** located at the **Media ejection slot**. Rotate the roller to expose the complete surface while cleaning.



4.3 HOW TO CLEAN THE PRINTER (CLEANING SHEET)

If certain stains on the print head cannot be removed easily with cotton swabs dabbed in cleaning solution, the cleaning sheet is used for clearing such stubborn debris on the print head.

1. Make sure the printer is powered off and remove the power cable.
2. Lift up the **main cover**.
3. Release the purple **head lock lever** by turning counter clockwise.
The **print head** is now accessible.
4. Remove the media and the ribbon.
5. Put the head **cleaning sheet** between the **print head** and the **platen roller**. The coarse side of the cleaning sheet should face the surface of the **print head elements**.
6. Now remount the print head by turning the **Head lock lever** clockwise until it latch on. The print head should lock into place firmly.
7. Using both hands, pull the **cleaning sheet** outwards, toward your body. This will remove any dirt stuck to the print head.

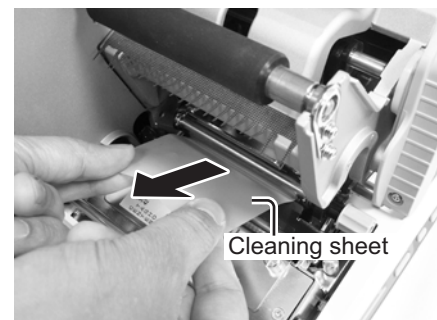

4.3 HOW TO CLEAN THE PRINTER (CLEANING SHEET) (Cont'd)

8. When the cleaning sheet has been removed, perform steps 5 to 7 to repeat the cleaning procedure one or two more times.
9. When no more additional dirt appears on the cleaning sheet after it has been pulled out, you can stop cleaning with the sheet.
10. Unlatch the print head and use the cleaning pen from the cleaning kit to gently remove any remaining dirt from the print head.

4.4 ADJUSTING PRINT QUALITY

Print quality can be optimized with regular cleaning and maintenance of the print head and components along the label path. Additionally, you can fine-tune print quality by adjusting print darkness and print speed settings.

4.4.1 Adjusting Print Darkness

This adjustment allows the user to control (within a specified range) the amount of power applied to the individual print head heat elements. It is important to find a proper print darkness level based on your particular label and ribbon combination. The printed images should not be too light nor should the ink from the ribbon “bleed.” The edges of each image should be crisp and well defined.

Print Darkness — The Print Darkness can be set from the USER Mode menu or by sending the Print Darkness software command from the host computer. There are three settings, from 1 (lightest) to 3 (darkest). The default setting is 2.

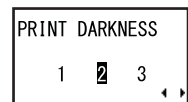

Once the range has been selected, the Darkness Setting of the Adjustment screen can be used to make finer adjustments. For instructions on setting Print Darkness, refer to **Section 3.6 User Mode**.

Darkness — The fine adjustment for Print Darkness is the Darkness adjustment on Adjustment screen. It provides a continuous range of adjustment, allowing you to make precise changes. See **Section 3.4 Adjustment Screen** for instructions on performing Darkness adjustments.



Note:

The DARKNESS adjustment will affect the darkness in all of the command code speed ranges, i.e., if the DARKNESS is adjusted for lighter print, the darkness will be lighter in all speed ranges selected by the command code.

4.4.2 Adjusting Print Speed

Besides varying the rate at which labels are printed, this adjustment can be used to regulate any changes in print quality.

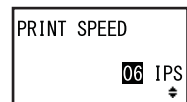

Print Speed— Print Speed can be set from the USER Mode menu or by sending the Print Speed software command from the host computer. There are 9 settings, from 02 ips (slowest) to 10 ips (faster). The default setting is 6 ips.

For instructions on setting Print Speed, refer to **Section 3.6 User Mode**.

5









TROUBLESHOOTING







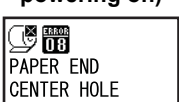

If you are unable to produce printouts on the TG3 series printer, use this section to make sure the basics have been checked, before deciding you are unable to proceed any further. The section is divided into four parts:

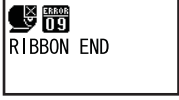
- 5.1 Error signal Troubleshooting
- 5.2 Troubleshooting Table
- 5.3 Interface Troubleshooting
- 5.4 Test Print Troubleshooting









5.1 ERROR SIGNAL TROUBLESHOOTING

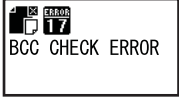

5.1.1 Error Message

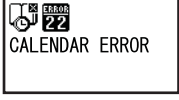
No.	ERROR DISPLAY	LED	BUZZER	ERROR CONDITION	CORRECTIVE ACTION
01	MACHINE ERROR 	ONLINE: Off ERROR: On	1 Long Beep	1) Defective PCB board To clear error: Power Off	1) Consult your SATO reseller or technical support center to replace the PCB board
02	FLASHROM ERROR 	ONLINE: Off ERROR: On	1 Long Beep	1) Access failure to Flash ROM 2) Exceeding maximum times of writing to Flash ROM. To clear error: Power Off	1) Consult your SATO reseller or technical support center to replace the PCB board
03	PARITY ERROR 	ONLINE: Blinks ERROR: On	3 short Beeps	1) Improper communication settings 2) Improper cable connection To clear error: Power Off	1) Correct the Parity Settings 2) Check the cable connection
04	OVERRUN ERROR 	ONLINE: Blinks ERROR: On	3 short Beeps	1) Improper communication settings 2) Improper cable connection To clear error: Power Off	1) Check and correct the flow control settings and retry 2) Check the cable connection
05	FRAMING ERROR 	ONLINE: Blinks ERROR: On	3 short Beeps	1) Improper communication settings 2) Improper cable connection To clear error: Power Off	1) Check and correct the data bit setting and retry 2) Check the cable connection
06	BUFFER OVER 	ONLINE: Blinks ERROR: On	3 short Beeps	1) Receiving oversized data for buffer capacity 2) Wrong protocol selected To clear error: Power Off	1) Change the host program not to send data exceeding buffer capacity 2) Adjust the host program to correct communication protocol
07	HEAD OPEN 	ONLINE: Off ERROR: Blinks	3 short Beeps	1) Print head is not latched. 2) Open/close micro-switch of head defect. To clear error: Latch Head	1) Latch Print head securely. 2) Adjust the micro-switch.
08	PAPER END 	ONLINE: Off ERROR: Blinks	3 short Beeps	1) Out of Paper (media) 2) Media is not properly set To clear error: Head open and then close	1) Replenish media supply 2) Route media through sensor correctly
	PAPER END (when powering on) 	ONLINE: Off ERROR: Blinks	3 short Beeps	1) Media is not set when turning on the printer To clear error: Head open and then close	1) Route media through sensor correctly 2) To change Paper type, press PAPER button while this screen is shown.

No.	ERROR DISPLAY	LED	BUZZER	ERROR CONDITION	CORRECTIVE ACTION
09	RIBBON END 	ONLINE: Off ERROR: Blinks	3 short Beeps	1) No ribbon 2) Ribbon torn To clear error: Head open and then close	1) Check ribbon loading and/or load a new ribbon roll 2) Clean or adjust the ribbon route
10	SENSOR ERROR 	ONLINE: Off ERROR: On	3 short Beeps	1) Improper pitch sensor level 2) Improper setting of sensor type 3) Media meandering To clear error: Head open and then close	1) Adjust pitch sensor level 2) Use the correct sensor for the media 3) Clean and adjust the media route
11	HEAD ERROR 	ONLINE: Off ERROR: On	1 long Beep	1) Print head damage • Error will be detected only when head check is enabled To clear error: Hold down FEED button or the combination of ONLINE + FEED more than 5 sec. to disable head check	1) Replace Print head or consult your SATO reseller or technical support center
12	MEMORY R/W ERROR 	ONLINE: Off ERROR: Blinks	1 long Beep	1) Memory writing error To clear error: Power Off	1) Confirm if Flash ROM memory is installed 2) Replace the memory board.
13	MEMORY FULL 	ONLINE: Off ERROR: Blinks	1 long Beep	1) Memory over capacity To clear error: Power Off	1) Delete unnecessary data
14	DOWNLOAD DATA ERROR 	ONLINE: Off ERROR: On	1 long Beep	1) Reception of unauthorized download data 2) No download area To clear error: Press FEED button	1) Check download data 2) Check download data size
15	CUTTER ERROR 	ONLINE: Off ERROR: Blinks	3 short Beeps	1) Media was jammed at the cutter part 2) Cutter's blade position is not correctly sensed. To clear error: Press FEED button	1) Clean up the cutter assembly 2) Adjust the belt at cutter part
16	CUT SENSOR ERROR 	ONLINE: Off ERROR: Blinks	3 short Beeps	1) The position of cut sensor is improper. To clear error: Head open and then close	1) Adjust the cutter sensor position or set the paper with specified size. Note: Pressing EJECT button while this error message is shown will perform cutting motion once.

Section 5: Troubleshooting

No.	ERROR DISPLAY	LED	BUZZER	ERROR CONDITION	CORRECTIVE ACTION
17	BCC CHECK ERROR 	ONLINE: Off ERROR: Blinks	3 short Beeps	1) BCC that is added to send data (for 1 item) differs. To clear error: Press ONLINE button or cancel job.	1) Check host data and communication settings
18	ITEM NO ERROR 	ONLINE: Off ERROR: Blinks	3 short Beeps	1) Sequence number of print data (for 1 item) is not incrementing by one. • Sequence number is not consecutive. To clear error: Press ONLINE button or cancel job.	1) Check host data and communication settings.
19	STACKER/REWINDER FULL 	ONLINE: Off ERROR: Blinks	3 short Beeps	1) Stacker and/or rewinder are full. To clear error: Release limitation	1) Remove paper from stacker and/or rewinder.
21	KANJI ROM ERROR 	ONLINE: Off ERROR: Blinks	3 short Beeps	1) Reading improper Kanji data through Kanji ROM. To clear error: Head open and then close	1) Download Kanji data. 2) Board replacement.
22	CALENDAR ERROR 	ONLINE: Off ERROR: On	1 Long Beep	1) Reading improper date and time data through calendar IC To clear error: Power Off	1) Check the installation of calendar IC. 2) Replace the calendar IC. 3) Replace the PCB board.
23	RFID TAG ERROR 	ONLINE: Off ERROR: On	3 short Beeps	1) Write failure of RFID tag To clear error: Write to another RFID tag or cancel job.	1) Write to another RFID tag.
	RFID TAG ERROR  PRESS LINE KEY	ONLINE: Off ERROR: On	3 short Beeps	1) Write failure of RFID tag To clear error: Press ONLINE button or cancel job.	1) Write to another RFID tag.
	RFID PROTECT ERROR 	ONLINE: Off ERROR: On	3 short Beeps	1) Write failure of RFID tag To clear error: Write to another RFID tag or cancel job.	1) Write to another RFID tag.
24	NONLOCK ERROR 	ONLINE: Off ERROR: Blinks	3 short Beeps	1) Ribbon core is not locked properly. 2) Ribbon core sensor failure. To clear error: Head open and then close	1) Lock ribbon core properly. 2) Adjust or replace ribbon core sensor.

No.	ERROR DISPLAY	LED	BUZZER	ERROR CONDITION	CORRECTIVE ACTION
25	MEDIA ERROR 	ONLINE: Off ERROR: Blinks	3 short Beeps	1) Specified media size is not correct. To clear error: Head open and then close	1) Set the specified size media
26	COMMAND ERROR  <ul style="list-style-type: none"> Command information of detected error will be shown at the bottom of LCD. 	ONLINE: Off ERROR: Blinks	3 short Beeps	1) Detecting improper command or parameter while printing. <ul style="list-style-type: none"> This screen appears only when command error display is enabled in Advanced Mode. To clear error: Press ONLINE button.	1) Check print data.
27	LATCH OPEN 	ONLINE: Off ERROR: Blinks	3 short Beeps	1) Lid latch is not locked properly. 2) Latch open sensor failure. To clear error: Close lid latch	1) Lock lid latch. 2) Adjust or replace latch open sensor.

5.1 ERROR SIGNAL TROUBLESHOOTING (Cont'd)

5.1.2 More information about Command Error

Printer Motion when detecting Command Error

When COMMAND ERROR DISPLAY is set to YES in Advanced Mode, the information of a command in which a command error was detected will be shown at the bottom of the screen, and the print operation will be paused. This error can be cleared by pressing the **ONLINE** button, but the data in which an error was detected will be dumped and print operation will not be performed.

Position of Error Occurrence

The location of command error is shown in "Caaa" where an error is being displayed.

The number of ESC commands from ESC+A will be shown in "aaa". Note that ESC+A is not included in the number of ESC commands, which can be displayed up to 999. If the number of ESC commands exceeds 999, it will be shown as "999".



Command information in which a command error was detected

Example)

When a command error is detected by Horizontal Print Position <H>.

```

----- : [ESC]A
C001 : [ESC]V100
C002 : [ESC]H99999      -> Location of command error
C003 : [ESC]L0202
C004 : [ESC]X2,ABCDEF
C005 : [ESC]Q1
C006 : [ESC]Z
    
```

In this case, **C002** is the location of error.

Error Command Name

Command name, in which an error was detected, will be shown in "<bb>" where an error is being displayed.

* When it is 1 byte command, it will be left aligned.

Error Code





Cause of command error will be indicated in code in "cc" where an error being displayed.

Code <cc>	Cause
01	Analyzed improper command
02	Received improper parameter
03	Analyzed improper graphic and external character data
04	Specified card slot is inappropriate
05	Number specified by registration command is already taken
06	Outside the registration area
07	Data is not registered
08	Specified print start position is outside the printable area
09	Printing image is outside the printable area (Barcode only)

5.1 ERROR SIGNAL TROUBLESHOOTING (Cont'd)

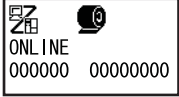
5.1.3 Warning Message

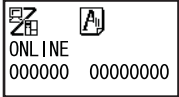
Note that the printer will continue issuing tag/label while detecting a warning message.

No.	WARNING DISPLAY	LED	BUZZER	ERROR CONDITION	CORRECTIVE ACTION
01	RIBBON NEAR END 	ONLINE: On ERROR: Off	-	1) Remaining ribbon length becomes short. To clear error: Head open (Ribbon replacement)	1) Change ribbon.
02	BUFFER NEAR FULL 	ONLINE: On ERROR: Off	-	1) Free space for receive buffer is low. To clear error: Cancel print operation or Data to create more than 1.95MB free space in receive buffer	1) Cancel print operation or data to create more than 1.95MB free space in receive buffer to clear an error.
03	COMMAND ERROR 	ONLINE: On ERROR: Off	1 short Beep	1) Detecting improper command in print data. 2) Print data is outside the printable area. • This screen appears only when command error display is disabled in Advanced Mode. To clear error: Normal data reception	1) Check data 2) Adjust print data and base reference point offset not to exceed the printable area.
04		ONLINE: On ERROR: Off	-	1) This message will be displayed after detecting and clearing an electrical disconnection error of print head temporarily with the FEED button. To clear error: Power Off (Print head replacement)	1) Print head replacement
05		ONLINE: Off ERROR: Off	-	1) The reference position is changed by the <#> command. • This warning appears only when [ADJUST FEED ACTION] is set to "STOP" in Advanced Mode, paper type is tag and cutter motion is "ON". To clear error: Press ONLINE button.	1) Remove a tag and press the printer and press ONLINE button. Or set [ADJUST FEED ACTION] to "CONTINUE" in Advanced Mode.

5.2 TROUBLESHOOTING TABLE

TROUBLESHOOTING TABLE	
IMAGE VOIDS	
Dirty print head.	Clean print head.
Defective print head.	Replace print head.
Defective main circuit board.	Have SATO authorised servicing personnel replace main board.
Damaged or worn platen roller.	Replace platen roller.
Poor label quality.	Use higher quality media. Use only SATO-certified media.
Ribbon stock and media are mismatched.	Consult with media supplier. Use only SATO-certified media.
RIBBON WRINKLING	
Poor head alignment.	Adjust head balance and alignment.
Poor ribbon tension.	Adjust tension as required.
Damaged or worn platen roller.	Replace platen roller.
Foreign material on print head and/or rollers.	Clean as required.
Foreign material on labels.	Use higher quality media. Use only SATO-certified media.
Defective print head.	Replace print head as required.
LIGHT PRINT IMAGES	
Low print head darkness.	Adjust darkness level setting.
Low print head pressure.	Adjust head pressure and/or balance.
Foreign material on print head.	Clean print head and platen roller.
Improper head alignment.	Align print head as required.
Excessive print speed.	Reduce print speed setting.
UNEVEN PRINT DARKNESS	
Unbalanced print head.	Adjust head balance.
Damaged or worn platen roller.	Replace platen rollers as required.
Dirty print head.	Clean print head as necessary.
MEANDERING MEDIA	
Incorrectly loaded media.	Ensure correct loading.
Improperly adjusted media guides.	Adjust as required.
Unbalanced print head.	Adjust as required.
Damaged or worn platen roller.	Replace platen roller as required.
SMEARED PRINT IMAGES	
Poor media quality	Use higher quality media. Use only SATO-certified media.
Foreign material on print head and platen roller	Clean print head and platen roller.
Foreign material on labels	Use higher quality media. Use only SATO-certified media.
Excessive print head energy	Adjust darkness level setting.
Excessive print speed	Adjust print speed as required.
Excessive print head pressure.	Adjust head balance.

5.2 TROUBLESHOOTING TABLE (Cont'd)

TROUBLESHOOTING TABLE	
NO LABEL MOVEMENT	
Loose or broken timing belt.	Replace or adjust as required.
Incorrect label sensor selected.	Check printer configuration for proper sensor selection.
No voltage output.	Replace fuse. Test power supply and replace as required.
Drive motor not operating.	Ensure wiring harness connection. Replace as necessary.
INCORRECT LABEL POSITIONING	
Incorrect label sensor selection.	Ensure the correct sensor is selected.
Improper sensor adjustment.	Adjust sensor sensitivity as required.
Data input error.	Ensure correct data stream.
Incorrect offset settings.	Adjust offset settings as required.
PRINTER CREATES A BLANK LABEL	
Data input error.	Ensure correct data stream.
Incorrect label sensor selection.	Set the sensor correctly.
Print head is disconnected.	Power off the printer and ensure a proper connection.
Defective print head.	Replace print head as required.
Defective main circuit board.	Have SATO authorised servicing personnel replace main board.
LCD FIELD ILLUMINATED BUT WITHOUT WORDS OR NO DISPLAY AT ALL	
Power supply issues.	Ensure cable properly connected. Check/replace power supply.
Screen contrast is incorrectly adjusted.	Adjust as required.

5.3 INTERFACE TROUBLESHOOTING

This chapter provides a checklist for the various interface types. Locate the checklist relative to the interface used and perform each of the troubleshooting tasks until the problem has been isolated.

PARALLEL INTERFACE	
CHK	TROUBLESHOOTING STEP
	Ensure the interface module is correctly installed. Run self-test to verify.
	Ensure the printer cable is connected to the appropriate LPT port on the host computer. If using a Windows printer driver, ensure the correct port is selected.
	Ensure a IEEE1284 printer cable is being used.
	Ensure the host's peripheral settings are set to ECP for faster throughput. Refer to the computer manufacturer's documentation for details.
	Ensure the printer is receiving information from the computer using the Receive Buffer Hex Dump mode. Refer to that procedure within this manual for instructions. The command stream should be continuous and possess 0Dhex and/or 0Ahex (carriage return and line feed) characters throughout. However, there should not be either located between the start (<ESC>A) and the stop (<ESC>Z) commands.
	Try another port to isolate the problem.
	Replace the main circuit board if determined to be the problem.

RS232 SERIAL INTERFACE	
CHK	TROUBLESHOOTING STEP
	Ensure the correct interface module is correctly installed. Run self-test to verify.
	Ensure the serial cable (Null Modem) meets specifications and is correctly connected at each end.
	Ensure the serial cable is not defective.
	Ensure the communication parameters for the baud rate, parity, data bits and stop bits are consistent with those being sent from the host computer.
	Ensure the printer is receiving information from the computer using the Receive Buffer Hex Dump mode. Refer to that procedure within this manual for instructions. The command stream should be continuous and possess 0Dhex and/or 0Ahex (carriage return and line feed) characters throughout. However, there should not be either located between the start (<ESC>A) and the stop (<ESC>Z) commands.
	Try another port to isolate the problem.
	Replace the main circuit board if determined to be the problem.

UNIVERSAL SERIAL BUS (USB) INTERFACE	
If nothing prints during a test print, verify the device drivers have been successively installed by performing the following:	
CHK	TROUBLESHOOTING STEP
	Click on Start, Settings, and then Control Panel.
	Click on System within the new window.
	Click on the Device Manager tab.
	Ensure that the View Device By Type is checked.
	Scroll to SATO-USB Device and ensure that errors do not exist. Reinstall as required.
	Reboot the PC and the printer.

LAN ETHERNET INTERFACE

CHK	TROUBLESHOOTING STEP
	Ensure the interface has been correctly configured. Wait two minutes and run self-test to verify. If a test label does not print, there may be a hardware problem.
	Ensure the cable and its ports are not defective.
	Ensure that a faulty print server or other protocol related scenarios are not creating a queue setup issue. Systematically perform checks and tests to isolate the cause.
	If using TCP/IP, ensure that a valid IP address is specified and that all parameters are correct (subnet mask, gateway, etc.). Attempt to PING the IP address assigned to the network interface.
	If using a repeater or hub, ensure the SQE is turned off. Also ensure the repeater port is not defective by trying the print server on another port.
	Install the IPX/SPX protocol on a workstation to determine if the network device can be discovered via the MAC address. If able, configure the appropriate protocols and retest connectivity.
	Use a crossover cable to isolate the printer from the network by connecting from the interface and workstation. Verify that the parameters match on each. Test connectivity.

WIRELESS LAN INTERFACE

CHK	TROUBLESHOOTING STEP
	Ensure the antenna is properly and completely installed.
	Ensure the wireless LAN unit is properly installed.
	Ensure the green connection lights on the back of the interface board are illuminated.
	If not obtaining an IP address, check the SSID or encryption and ensure those were properly entered.

5.4 TEST PRINT TROUBLESHOOTING

Chapter provides instruction on special printing to identify and resolve specific print problems.

5.4.1 Hex Dump

Allows the operator to determine if there were problems in the downloading of data. The contents of the print buffer can be examined using the Hex Dump Mode. In the left column, each line of data received is numbered. The center column provides the data in hexadecimal format. And in the right column, the same data is provided in the ASC II format. Refer to **Section 3.10 HEX Dump Mode** for more details to perform this activity.

5.4.2 Test label printing

Allows the operator to identify specific problems regarding mechanical performance and setup. The test label is designed to assist in the identification of print problems. Refer to **Section 3.12 Test Print Mode** for more details to perform this activity.

This page is intentionally left blank

6

BASIC SPECIFICATIONS

6.1 PRINTER BASIC SPECIFICATIONS

MODEL NAME	TG308 / TG312
-------------------	---------------

PHYSICAL CHARACTERISTICS	
Width	284 mm (11.18")
Height	300 mm (11.81")
Depth	552 mm (21.73")
Weight	16.2 Kg (35.71 lbs.)

POWER SUPPLY		
Input Voltage	Input power voltage: AC 100V - 240V, +/-10% (Full range) Rated input voltage: AC 100V - 240V (Full range)	
Power Consumption	When not using an optional device:	At peak: 132W / 134VA (Print ratio 30%) In standby: 20W / 22VA
	When stacker and Keypad are connected:	At peak: 157W / 161VA (Print ratio 30%) In standby: 25W / 28VA

ENVIRONMENTAL (EXCLUDING MEDIA)	
Operating Temperature	5° to 40°C (41 to 104 F)
Storage Temperature	-5° to 60°C (23 to 140 F)
Operating Humidity	30 to 80% RH, Non-condensing
Storage Humidity	30 to 90% RH, Non-condensing

PRINT	
Method	Thermal Transfer and Direct Thermal
Print Speed (selectable)	50 to 250 mm/sec (2 to 10 Inch/sec) (Setting value: 2, 3, 4, 5, 6, 7, 8, 9, 10) *Print speed varies depending on the of media used.
Resolution	TG308: 8 dots/mm (203 Dots Per Inch) TG312: 12 dots/mm (305 Dots Per Inch)
Maximum Print Width	80 mm (3.1")
Maximum Print Length	240 mm (9.4 ")
Print darkness	Darkness range: A to F Darkness level: 1 to 3

Section 6: Basic Specifications

MEDIA (Be sure to use media manufactured or certified by SATO)		
Size	Label Continuous Width: 22 to 80 mm (0.9" to 3.1") Width including liner: 25 to 83 mm (1.0" to 3.3") Pitch: 16 to 237mm (0.6" to 9.3") Pitch including liner: 19 to 240 mm (0.7" to 9.4") Cutter Width: 22 to 80 mm (0.9" to 3.1") Width including liner: 25 to 83 mm (1.0" to 3.3") Pitch: 22 to 237mm (0.9" to 9.3") Pitch including liner: 25 to 240 mm (1.0" to 9.4") Tag Continuous Width: 32 to 83 mm (1.3" to 3.3") Pitch: 25 to 240mm (1.0" to 9.4") Cutter Width: 32 to 83 mm (1.3" to 3.3") Pitch: 25 to 240mm (1.0" to 9.4") * The size may be limited by use conditions.	
	Type	Direct Thermal/ Thermal Transfer Use roll media specified by SATO.
	Roll Diameter	Maximum outer diameter: 250 mm (10")
	Core Diameter	Inner core diameter: 76.4 mm(3") and 102 mm (4"), depending on media type *The supplied boss is required for loading 102 mm (4") roll core.
Thickness	Label: 0.14 to 0.265 mm (0.006 to 0.01 in.) Tag: 0.157 to 0.33 mm (0.006 to 0.013 in.) *For details on support for RFID tags, please contact your nearest SATO reseller or technical support center.	
Wind Direction	Face-out/ Face-In	

RIBBON (Be sure to use ribbon manufactured or certified by SATO)	
Width	Max. 84mm (3.3")
Length	Max. 450 m (1476.3 ft.) (Depending on ribbon type)
Wind Direction	Face-out/ Face-In
Winding Method	Coreless roll (Standard), Rolled onto a core (Option)

PROCESSING	
CPU	32 Bit RISC-CPU 100MHz
Flash ROM	8 Megabytes
SDRAM	16 Megabytes

PRINTER LANGUAGE	
Standard	SATO Barcode Printer Language (SBPL)

INTERFACES	
Interface Board	1) Plug-in Interface board (1 slot) 2) EXT (External) connector (for optional devices such as stacker and label rewinder) 3) RS-232C D-sub 9-pin type (for keypad only)
Optional Plug-in interface boards	1) RS-232C (High-Speed) I/F board 2) IEEE1284 (ECP/Compatible) I/F board 3) LAN I/F board 4) Wireless (LAN IEEE802.11b/g)/ Wired LAN I/F board The board comes with a wired LAN connector. However, the simultaneous use of a wireless connection and wired connection is not possible. 5) USB I/F board (Full-Speed)

SENSING	
Gap/ Center Tag hole (Transmissive)	Position & Sensitivity Adjustable
I-Mark (Reflective)	Sensitivity Adjustable
Side Tag hole	Sensitivity Adjustable
R-corner /Notch Tag hole	Sensitivity Adjustable
Jump-hole	Sensitivity Adjustable
Head Open	Fixed
Ribbon End	Fixed
Lid latch open	Fixed
Cutter	Position & Sensitivity Adjustable

SELF-DIAGNOSIS FUNCTION	
	1) Broken head element check 2) Paper end detection 3) Test print 4) Ribbon end detection 5) Ribbon near-end detection 6) Kanji data check 7) Head open 8) Lid latch open 9) Cutter error 10) Stacker full (Only when an optional stacker is installed) 11) Take-up spindle full (Only when an optional rewinder is installed)

CHARACTER FONT CAPABILITIES	
MATRIX FONTS	
WB text	18 dots W x 30 dots H (Alphanumeric, symbols)
WL text	28 dots W x 52 dots H (Alphanumeric, symbols)
S text	8 dots W x 15 dots H (Alphanumeric, symbols)
M text	13 dots W x 20 dots H (Alphanumeric, symbols)
U text	5 dots W x 9 dots H (Alphanumeric, symbols)
XU	5 dots W x 9 dots H (Alphanumeric, symbols)

CHARACTER FONT CAPABILITIES	
MATRIX FONTS	
XS	17 dots W x 17 dots H (Alphanumeric, symbols)
XM	24 dots W x 24 dots H (Alphanumeric, symbols)
XB	48 dots W x 48 dots H (Alphanumeric, symbols)
XL	48 dots W x 48 dots H (Alphanumeric, symbols)
OA Font (OCR-A)	TG308: 15 dots W x 22 dots H (Alphanumeric, symbols) TG312: 22 dots W x 33 dots H (Alphanumeric, symbols)
OB Font (OCR-B)	TG308: 20 dots W x 24 dots H (Alphanumeric, symbols) TG312: 30 dots W x 36 dots H (Alphanumeric, symbols)
X70	32 dots W x 48 dots H (Numeric, "\$¥-,") Italic
X71	40 dots W x 60 dots H (Numeric, "\$¥-,") Italic
X72	48 dots W x 72 dots H (Numeric, "\$¥-,") Italic
X73	64 dots W x 96 dots H (Numeric, "\$¥-,") Italic
X74	32 dots W x 48 dots H (Numeric, "\$¥-,") Standard
X75	40 dots W x 60 dots H (Numeric, "\$¥-,") Standard
X76	48 dots W x 72 dots H (Numeric, "\$¥-,") Standard
X77	64 dots W x 96 dots H (Numeric, "\$¥-,") Standard
XCS text	32 dots W x 24 dots H (Symbols)
XCL text	48 dots W x 36 dots H (Symbols)
KANJI FONTS	
	Supported by downloading one of the following kanji fonts. 1) Simplified Chinese (2.6MB) GB2312 (24 x 24 dot) 2) Korean (1.6MB) KSX1001 (16 x 16 dot) KSX1001 (24 x 24 dot)
RASTERIZED FONTS	
	<Standard installation> CG Times (Alphanumeric, symbols) CG Triumvarite (Alphanumeric, symbols) <Each model> *To be installed in extended memory before shipment 1) TG308/TG312 (English version) • Future II book • CG Palacio • CG Century Schoolbook • CG Triumvirate Condensed • Univers Medium • CG Times 2) TG308/TG312 (European version) • Univers Medium • CG Times 3) TG308/TG312 (Chinese version) • Traditional Chinese (MKaiSO-Medium-U) • Simplified Chinese (MHeiS-Bold-U) 4) TG308/TG312 (Korean version) • Korean (HY Round Gothic)

CHARACTER FONT CAPABILITIES	
OUTLINE FONTS	
	Alphanumeric characters and symbols
CHARACTER CONTROL	
Magnification	Expansion up to 12 x in either the vertical or horizontal
Rotation	0°, 90°, 180° and 270°

BARCODE CAPABILITIES	
Linear Bar Codes	UPC-A/E EAN-13/8 CODE39 CODE93 CODE128(UCC/EAN-128) (Character set: SET-A, SET-B, SET-C) CODABAR(NW-7) SATOC CODABAR(NW-7) Short CODARBAR(NW-7) ITF Interleaved 2 of 5 Industrial 2 of 5 Matrix 2of5 MSI BOOKLAND POSTNET GS1 DataBar (RSS): GS1 DataBar Omnidirectional, GS1 DataBar Truncated, GS1 DataBar Stacked , GS1 DataBar Stacked Omni-Directinal, GS1 DataBar Limited GS1 DataBar Expanded, GS1 DataBar Expanded Stacked * GS1 DataBar is new version of "RSS".
Two Dimensional	QR code (Ver 8.1 including Micro QR) PDF417 (Ver 2.4 including Micro PDF) MAXI code (Ver 3.0) GS1 DataMatrix (Ver2.0) *Only ECC200 is supported
Composite Symbols	EAN-13 Composite (CC-A/CC-B) EAN-8 Composite (CC-A/CC-B) UPC-A Composite (CC-A/CC-B) UPC-E Composite (CC-A/CC-B) GS1-128 Composite (CC-A/CC-B/CC-C) GS1 DataBar Composite (CC-A/CC-B) GS1 DataBar Truncated Composite (CC-A/CC-B) GS1 DataBar Stacked Composite (CC-A/CC-B) GS1 DataBar Stacked Omni-Directional Composite (CC-A/CC-B) GS1 DataBar Limited Composite (CC-A/CC-B) GS1 DataBar Expanded Composite (CC-A/CC-B) GS1 DataBar Expanded Stacked Composite (CC-A/CC-B) * GS1 DataBar is new version of "RSS".
Ratios	1:2, 1:3, 2:5, User definable bar widths
Rotation	Parallel 1 (0°), Parallel 2 (180°), Serial 1 (90°) and Serial 2 (270°)
Magnification	1 to 12 times

VERSATILE FUNCTIONS	
	<ol style="list-style-type: none"> 1) Status return function 2) Graphics function 3) Sequential number function 4) Form overlay function 5) Non-standard character store function 6) Black/white inversion function 7) Line/Box drawing function 8) Format store function 9) Zero slash switching function 10) JIS/Shift-JIS selection function 11) Tag/Label auto feed function (First tag and label are not wasted) 13) Eject and cut function 14) Item cut function

HARDWARE AND RELATED	
Operation keys	<ol style="list-style-type: none"> 1) Power switch 2) ONLINE button 3) FEED button 4) CUTTER button 5) EJECT button 6) FUNCTION button 7) PAPER button 8) Arrow buttons: <, >, ^, v
Indicators	ON LINE: Green LED CUTTER: Green LED ERROR: Red LED
Buzzer	Built-in buzzer • No volume control function available

OPTIONS	
	<ol style="list-style-type: none"> 1) Large-size stacker (ST-TG3) 2) Label rewinder (RWG500) 3) Label rewinder (RW-TG3) 4) RFID kit (with proprietary cutter) (HF-band, UHF-band, 2.45GHz) 5) Ribbon core adapter kit (comes with a core) 6) Keypad

REGULATORY COMPLIANCE	
Safety regulation	UL60950-1(2001) (USA) CSA22.2 No.60950-1-30 (Canada) EN60950-1, CE (Europe) CCC (GB4943-2001) (China)
EMC regulation	FCC15B Class B (USA/Canada) CE (EN55022, EN55024) (Europe) GB9254-1998, GB17625.1(2003) (China) MIC (KN22, KN24) (Korea)

REGULATORY COMPLIANCE	
Radio Standards Wireless LAN(2.45MHz)	FCC15B /FCC15C (USA/Canada) R&TTE (EN300 328 V1.4:2003-04),(EN301 489 V1.4.1:2002-08) (Europe) SRRC (信部无 [2001]653 号) (China) MIC (Korea)
Radio Standards RFID(HF/ UHF)	FCC15B /FCC15C (USA/Canada) R&TTE (EN300-330) (HF-band RFID, Europe) R&TTE (EN300-220-1/EN302-208-1) (UHF-band RFID, Europe) MIC (Korea)
Packaging Drop Standard	ISTA-2A
Environmental (RoHS)	Chromium: below 0.1% Lead: below 0.1% Mercury: below 0.1% Cadmium: below 0.01% Polybrominated Biphenyl (PBB): below 0.1% Polybrominated Diphenyl Ether (PBDE): below 0.1%

6.2 OPTIONAL ACCESSORIES SPECIFICATIONS

LARGE-SIZED STACKER SPECIFICATIONS	
Model name	ST-TG3
Maximum stack height	150mm (5.9") (Paper thickness 0.26 mm (0.01"), approximately 500 tags)
Tag feed speed	250mm/sec (9.8" per sec)
Media Type	Tag only (Use of label is not acceptable) * Refer to the Consumables Specifications for more details. Make sure the tag size meets the following conditions.
Media Size	Tag Width: 32 to 83 mm (1.3" to 3.3") Pitch: 25 to 150 mm (1" to 5.9") * Use the optional weight when the tag length is 90mm or more. * Use the optional spacer when the length of laminated tag and glossy tag are 90mm (3.5") or more.
Thickness	Tag: 0.159 to 0.33 mm (0.006" to 0.013") Some restrictions may apply to the tag size due to tag curling when the diameter of tag roll core is 3-inch.
Tag pressure	Weight load type
Sensor	Movable tag full sensor Outputs the "stacker full" signal to the EXT (the printer) at the time of error occurrence.
Communication (Connection)	Input: Amphenol 14-pin Male (EXT connector connection) * Connecting with the computer (Rewinder and daisy connection inside) EXT terminal (for handshake): #3 (Input): Winding motor control #5 (Output): Rewinder full + stacker full #6 (Input): Stacker motor control Output: Amphenol 14-pin Female (EXT connector connection) * Connecting with the rewinder (RWG500/RWS300) EXT terminal (for handshake): #3 (Input): Winding motor control #5 (Output): Rewinder full
Power supply	Supplied from the printer unit (EXT connector). EXT terminal: # 2 : GND # 12 : DC+24V # 13 : DC+5V
Motor	Stepping motor (Interfaces with the printer) 2-phase unipolar type stepping motor
Dimensions	W 219 X D 245 X H 300 mm (W 8.6" X D 9.6" X H 11.8")
Weight	3.4 kg (7.5")
Fixation (Installation) method	Simple fixation by joint plate. * Can be set by the users.
Accessories	Tag stopper, Joint plate, Optional weight (For the tag length of 90mm or more), Optional spacer with magnet (Use the optional spacer when the length of laminated tag and glossy tag are 90mm or more), Instruction guide for optional spacer

EXTERNAL LABEL REWINDING UNIT SPECIFICATIONS	
Model name	RW-TG3
Rewinding length	Maximum 100m (328 feet)
Maximum diameter	107mm (4.2")
Rewinding speed	Max. 250mm/sec (Max. 10" per sec)
Media Type	Label only
Media Size	Width including liner: 22 to 80 mm (0.87" to 3.15") Winding direction: Face in Winding method: Winding the label onto the core directly by the rewind knob.
Sensor	Label rewinder full detection (Switch) Outputs a "rewinder full" signal to the EXT (the printer) at the time of error occurrence.
Communication (Connection)	Amphenol 14-pin Male (EXT connector connection) * Connecting to the printer and stacker EXT terminal (for handshake): #3 (Input): for motor control #5 (Output): Rewinder full
Power supply	Supplied from the printer unit (EXT connector): DC + 24V 2A EXT terminal (for receiving power): # 2 : GND # 12 : DC+24V # 13 : DC+5V
Motor	Interfaces with the printer (Driven by the signal from the printer) 4-phase unipolar type stepping motor
Dimensions	W 177X D 114 X H 216 mm (W 7" X D 4.5" X H 8.5")
Weight	1.4 kg (1.5 lbs)
Fixation (Installation) method	Simple fixation by joint plates. * Can be set by the user.
Accessories	Two joint plates

This page is intentionally left blank

7

INTERFACE SPECIFICATIONS

This section presents the interface types and their specifications for the TG3 series printers. These specifications include detailed information to assist in the selection of the most appropriate method for the printer to interface with the host.

The following information is presented in this section:

- 7.1 Interface Types
- 7.2 RS232C High Speed Serial Interface
- 7.3 IEEE 1284 Parallel Interface
- 7.4 Universal Serial Bus (USB) Interface
- 7.5 Local Area Network (LAN) Ethernet
- 7.6 Wireless LAN Ethernet
- 7.7 LAN and Wireless LAN Ethernet Specifications
- 7.8 External Signal Interface (EXT)

7.1 INTERFACE TYPES

TG3 series printers are equipped with an interface board to perform data communication with the host, an external signal interface to connect peripheral devices to the printer, and an interface to connect a keypad to the printer.

In order to provide flexibility in communicating with a variety of host computer systems, this printers use a Plug-In Interface Module.

The following interface boards are available.

- 1) RS-232C (High-speed) interface board
- 2) IEEE1284 interface board
- 3) USB interface board
- 4) LAN interface board
- 5) Wireless LAN interface board

**Caution**

- Always turn the printer off before attaching or detaching an interface card. Otherwise, severe electrical damage may be incurred, or bodily injury may be sustained.
- Never connect or disconnect interface cables (or use a switch box) with power applied to either the host or printer. This may caused damage to the interface circuitry in the printer/ host and is not covered by warranty.

7.2 RS232C HIGH SPEED SERIAL INTERFACE

7.2.1 RS-232C Serial Interface Card DIP SWITCH Settings

The high-speed serial interface card (optional) contains DIP switches for controlling communication conditions. Determine what features are applicable to your setup, or desired setup, and adjust their respective DIP switches as applicable.

There are 8 switches in a row and all are default setting at Off position. The DIP switch functions are as follow:

DIP switch No.	Function	Setting Description		
1	Data bit length	ON		7 bits
		OFF		8 bits
2 3	Parity setting	DIP sw 2	DIP sw 3	Not used
		ON	ON	
		ON	OFF	ODD
		OFF	ON	EVEN
		OFF	OFF	NONE
4	Stop bit setting	ON		2 bits
		OFF		1 bit
5 6	Baud rate setting	DIP sw 5	DIP sw 6	57600bps
		ON	ON	
		ON	OFF	38400bps
		OFF	ON	19200bps
		OFF	OFF	9600bps
7 8	Communication Protocol setting	DIP sw 7	DIP sw 8	STATUS4
		ON	ON	
		ON	OFF	STATUS3
		OFF	ON	XON/XOFF
		OFF	OFF	READY/BUSY



FUNCTION DESCRIPTIONS	
Function	Description
Data bit length	Sets the printer to receive either 7 or 8 bits of data for each byte transmitted.
Parity setting	Selects the type of parity used for error detection.
Stop bit setting	Selects the number of stop bits to end each byte transmission.
Baud rate setting	Select the data rate (bps) for the RS232 port.
Communication Protocol setting	Selects the flow control and status reporting protocols

7.2 RS232C HIGH SPEED SERIAL INTERFACE (Cont'd)

Notes:

- Check the setting seal of the serial interface card.
The correct settings may vary depending on the type and revision of the board.
- The setting range of baud rate and protocol can be changed in the printer's Interface Mode. See **Section 3.7 Interface Mode** for details.
- Baud rate 2400bps and 4800bps can be set in the Interface Mode of the printer only. STATUS5 for "Protocol" can be set in the Interface Mode of the printer only.
- Single item buffer or multi buffer can be set in the printer's Interface Mode when [READY/BUSY] and [XON/XOFF] are effective.

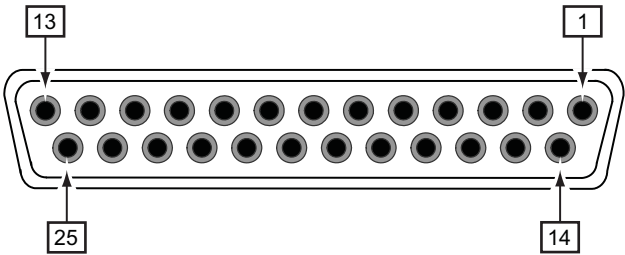
7.2.2 Basic Specifications

Interface connector	 <p style="text-align: center;">Serial Connector Pin Assignments</p>											
Synchro system	Asynchronous method											
Maximum receive buffer capacity	<p>2.95MB</p> <p style="text-align: center;">0MB 2.95MB</p> <p>Buffer near full occurred  Remaining 0.95MB</p> <p>Buffer near full released  Remaining 1.95MB</p>											
Code	ASCII (7 bits), Graphic (8 bits)											
Connectors	Printer side Cable side Cable length	DB-25S (male) or equivalent DB-25P (female) or equivalent 5m and under										
Transmission form	<table border="1" style="width: 100%; text-align: center;"> <tr> <td>Start</td> <td>b1</td> <td>b2</td> <td>b3</td> <td>b4</td> <td>b5</td> <td>b6</td> <td>b7</td> <td>b8</td> <td>Stop</td> </tr> </table> <p>[Note] If using 7 bits, b8 will be omitted.</p>		Start	b1	b2	b3	b4	b5	b6	b7	b8	Stop
Start	b1	b2	b3	b4	b5	b6	b7	b8	Stop			
Signal level	<p>High level : +5 to +12V</p> <p>Low level : -5 to -12V</p>											

7.2 RS232C HIGH SPEED SERIAL INTERFACE (Cont'd)

7.2.3 Ready/Busy

Ready / Busy is the hardware flow control method for the serial interface on the printer. Single item buffer and multi buffer can be toggled in the Interface Mode of the printer.

When the print data (STX ESC+"A"~ ESC+"Z" ETX) is sent from the host in the conditions below, received data may be incorrect.

- 1) When the printer is Offline
- 2) When an error has occurred in the printer

Pin Assignments

1) Host with DB-25 P terminal

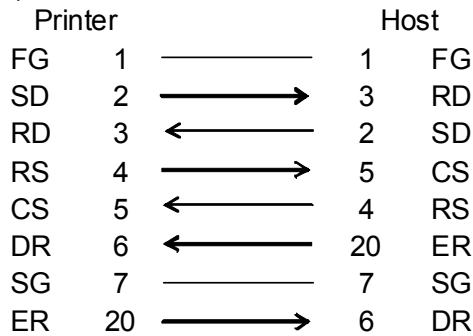

2) Host with DB-9P terminal

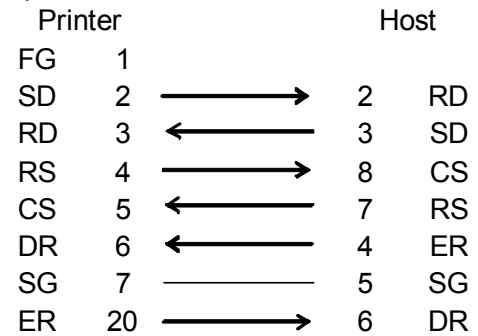

When using Windows Hardware Control:

3) Host with DB-25 P terminal

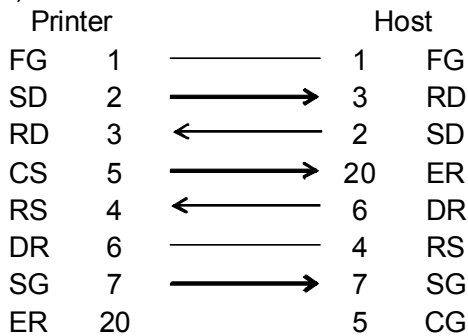

4) Host with DB-9P terminal

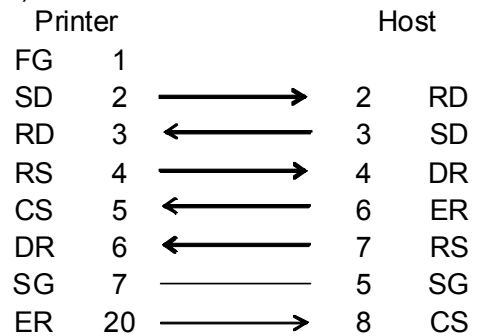

Interface Signals

Pin no.	Signal Type	Direction	Description
1	FG	-	Frame ground
2	SD	Output	Data from the printer to the host computer.
3	RD	Input	Data from the host computer to the printer.
4	RS	Output	It goes "Low" when an error has occurred in the printer
5	CS	Input	It must be "High".
6	DR	Input	It must be "High".
7	SG	-	Signal ground
20	ER	Output	It goes "High" when the printer is ready to receive data. It goes "Low" when an error has occurred in the printer or when the printer is in offline state.

7.2 RS232C HIGH SPEED SERIAL INTERFACE (Cont'd)

7.2.4 X-ON/X-OFF

This transmission protocol informs the host if the printer can receive data or not, by sending the "XON" (Hex 11H) or "XOFF" (Hex 13H) code.

When the print data (STX ESC+"A"~ ESC+"Z" ETX) is sent from the host in the conditions below, received data may be incorrect.

- 1) When the printer is Offline
- 2) When an error has occurred in the printer

Pin Assignments

1) Host with DB-25 P terminal

Printer			Host	
FG	1	—————	1	FG
SD	2	—————→	3	RD
RD	3	←—————	2	SD
RS	4		5	CS
CS	5		4	RS
DR	6		20	ER
SG	7	—————	7	SG
ER	20		8	DR

2) Host with DB-9 P terminal

Printer			Host	
FG	1		1	FG
SD	2	—————→	2	RD
RD	3	←—————	3	SD
RS	4		8	CS
CS	5		7	RS
DR	6		4	ER
SG	7	—————	5	SG
ER	20		6	DR

Note:

Depending on the host used, it may need to loop CS and RS (maintaining at "High" level) on the host side. Therefore, make sure to re-check the host before use.

Input/Output Signals

Pin no.	Signal Type	Direction	Description
1	FG	-	Frame ground
2	SD	Output	Data transferred from the printer to the host
3	RD	Input	Data transferred from the host to the printer
7	SG	-	Signal ground

7.3 IEEE 1284 PARALLEL INTERFACE

The IEEE 1284 Interface on the printer complies with Centronics/ IEEE1284 standards. It will automatically detect the IEEE1284 signals and operate in the high speed mode. If it does not detect the IEEE1284 signals, it will operate in the standard Centronics mode, which is significantly slower. For this reason, an interface cable and host interface conforming to the IEEE1284 specification must be present to fully utilize the speed capabilities. Single-item buffer and multi buffer are available for the receive mode, and switchblade in the Interface Mode of the printer.

The ECP mode is recommended for LPT1 port settings.

Make sure to change the LPT1 port settings through the BIOS settings.

7.3.1 Basic Specifications

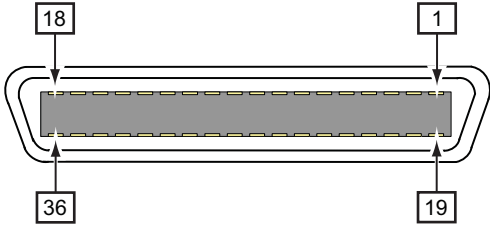
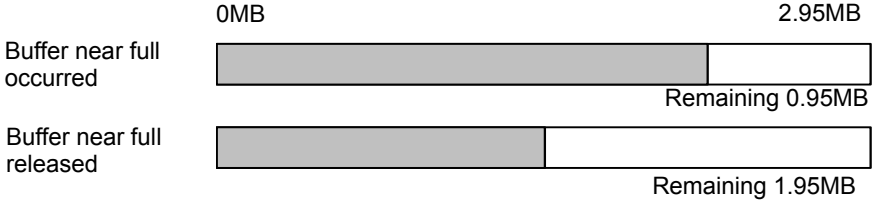
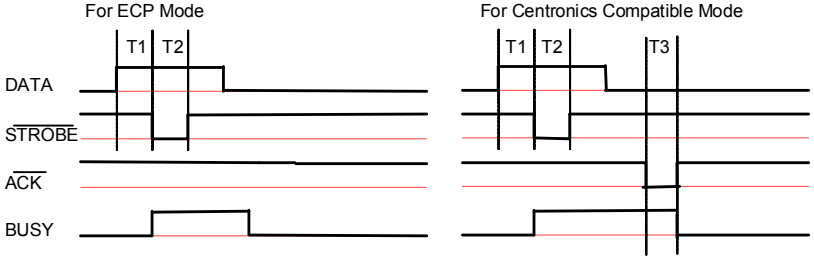
Interface connector	 <p style="text-align: center;">Parallel Connector Pin Assignments</p> <p>Printer side: Amphenol (DDK) 57 to 40360 or equivalent Cable side: Amphenol (DDK) 57 to 30360 or equivalent</p>
Cable length	1.5m or less
Signal level	High level : +2.4 to +5.0V Low level : +0.0 to +0.4V
Receive mode	Single-item buffer Multi buffer Go to the Interface Mode of the printer for the setup of receive mode.
Maximum receive buffer capacity	2.95MB 
Timing chart	 <p>(1) $1.0\mu s < T1, T2$ $0.6\mu s < T3 < 1.2\mu s$ (2) For single-item buffer, ACK length(0.5~12.0μs) is settable in the Interface Mode.</p>

Note:

Send print data while the printer is on.

7.3 IEEE 1284 PARALLEL INTERFACE (Cont'd)

7.3.2 Pin Assignments

Pin assignment of each signal for the Centronics standard (Compatible Mode) is as follows.

Note that the line connection for the IEEE1284 standard is based on the IEEE1284-B standard.

PIN No.	Signal	I/O	PIN No.	Signal	I/O
1	$\overline{\text{STROBE}}$	Input	19	STROBE-RETURN	SG
2	DATA 1	Input	20	DATA 1-RETURN	SG
3	DATA 2	Input	21	DATA 2-RETURN	SG
4	DATA 3	Input	22	DATA 3-RETURN	SG
5	DATA 4	Input	23	DATA 4-RETURN	SG
6	DATA 5	Input	24	DATA 5-RETURN	SG
7	DATA 6	Input	25	DATA 6-RETURN	SG
8	DATA 7	Input	26	DATA 7-RETURN	SG
9	DATA 8	Input	27	DATA 8-RETURN	SG
10	$\overline{\text{ACK}}$	Output	28	ACK -RETURN	SG
11	BUSY	Output	29	BUSY -RETURN	SG
12	PE	Output	30	PE -RETURN	SG
13	SELECT	Output	31		
14			32	$\overline{\text{FAULT}}$	Output
15			33		
16			34		
17	FG	Frame ground	35		
18	24kohm (+ 5V)		36		

7.3 IEEE 1284 PARALLEL INTERFACE (Cont'd)

7.3.3 Input and Output Signals



The details of each signal line for the Centronics standard (Compatible Mode) are as follows. Note that each signal line complies with the IEEE1284 standard.

Pin No.	Signal	I/O	Description
1	$\overline{\text{STROBE}}$	Input	Synchronization signal that requires low active pulse to read DATA1 ~ DATA8
2~9	DATA 1 ~ DATA 8	Input	Data entry of 8bits parallel: DATA1 --LSB (lowest bit) DATA8 --MSB (highest bit)
10	$\overline{\text{ACK}}$	Output	Low active pulse signal indicating the completion of receive data import
11	BUSY	Output	High active signal indicating that the printer is not ready to receive data
12	PE	Output	High active signal indicating paper shortage
13	SELECT	Output	High active signal indicating that the printer is ready to receive data
14	AUTOFD	Input	Signal for the IEEE1284 standard
17	CHASSIS GND		Connecting to framework ground
18	PERIPHERAL LOGIC HIGH	Output	+5V voltage on the printer side
19~30	SIGNAL GND		Connecting to each signal ground
31	$\overline{\text{INIT}}$	Input	Low active pulse signal requesting to reset the printer
32	$\overline{\text{FAULT}}$	Output	Low active pulse signal indicating an error in the printer
33	$\overline{\text{SELECTIN}}$	Input	Signal for the IEEE1284 standard

7.4 UNIVERSAL SERIAL BUS (USB) INTERFACE

The Universal Serial Bus (USB) interface is a Plug-In Interface Module that can be installed by the user. It requires a driver (shipped with each printer that has the interface installed) that must be loaded on your PC and the PC must be configured to support USB peripherals using Windows 2000 or above. Details for loading the USB driver are contained in the USB Interface Manual that is shipped with each printer with a USB Optional interface installed. Up to 127 devices may be connected to a USB port using powered hubs.

7.4.1 Basic Specifications

Interface connector	Series B plug Cable length: 5m or less (Twisted Pair Shielded)		
Version	USB 2.0		
Maximum receive buffer capacity	2.95MB	0MB	2.95MB
	Buffer near full occurred		Remaining 0.95MB
	Buffer near full released		Remaining 1.95MB

7.4.2 Pin Assignments

Pin No.	Description
1	VBus
2	-Data(D-)
3	+Data(D+)
4	GND

7.5 LOCAL AREA NETWORK (LAN) ETHERNET

A Local Area Network (LAN) interface is an optional Plug-In Interface Module that can be installed by the user. It requires a driver shipped with each printer that has the interface installed. The driver that must be loaded on the host computer and configured to run one of the supported network protocols using a 10/100BaseT LAN connection. Details for loading the LAN driver are contained in the LAN Interface Manual that is shipped with each printer with a LAN Optional interface installed.

7.5.1 Basic Specifications

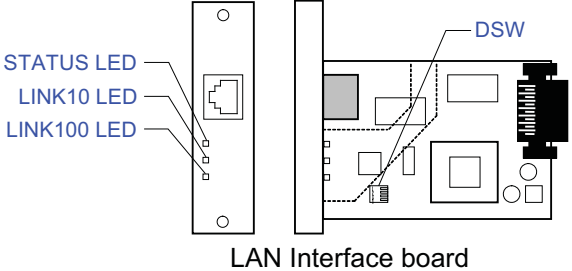
<p>Interface connector</p>	 <p style="text-align: center;">LAN Interface board</p> <p>Cable type: For 10BASE-T and 100BASE-TX Cable length: 100m or less</p>												
<p>Link/Status LED</p>	<p>Status LED lights up when establishing the LINK with Ethernet device or when receiving the packets. The LINK is established by Auto Negotiation.</p> <table border="1" data-bbox="518 1052 1380 1299"> <thead> <tr> <th>LED</th> <th>Color</th> <th>Conditions</th> </tr> </thead> <tbody> <tr> <td>STATUS</td> <td>Orange</td> <td>Lights up for 10ms when receiving packets</td> </tr> <tr> <td>LINK10</td> <td>Green</td> <td>Lights up when recognizing the connection to 10BASE-T</td> </tr> <tr> <td>LINK100</td> <td>Green</td> <td>Lights up when recognizing the connection to 100BASE-TX</td> </tr> </tbody> </table> <p>* Make sure to turn DSW1 "OFF".</p>	LED	Color	Conditions	STATUS	Orange	Lights up for 10ms when receiving packets	LINK10	Green	Lights up when recognizing the connection to 10BASE-T	LINK100	Green	Lights up when recognizing the connection to 100BASE-TX
LED	Color	Conditions											
STATUS	Orange	Lights up for 10ms when receiving packets											
LINK10	Green	Lights up when recognizing the connection to 10BASE-T											
LINK100	Green	Lights up when recognizing the connection to 100BASE-TX											
<p>DSW</p>	<p>DSW is a maintenance switch to initialize the setup of LAN board and to print out the setup information. Make sure to turn all DSW "OFF" when using the printer.</p> <table border="1" data-bbox="518 1422 1380 1747"> <thead> <tr> <th>DSW</th> <th>Operation when turning the printer on while DSW is ON</th> </tr> </thead> <tbody> <tr> <td>1</td> <td>Not used (Setup prohibited)</td> </tr> <tr> <td>2</td> <td>LAN board EEPROM initialization (Initializing configuration)</td> </tr> <tr> <td>3</td> <td>Print of configuration (Printing configuration details on a label)</td> </tr> <tr> <td>4</td> <td>Print of self-diagnosis (Printing diagnostic result of the board)</td> </tr> </tbody> </table>	DSW	Operation when turning the printer on while DSW is ON	1	Not used (Setup prohibited)	2	LAN board EEPROM initialization (Initializing configuration)	3	Print of configuration (Printing configuration details on a label)	4	Print of self-diagnosis (Printing diagnostic result of the board)		
DSW	Operation when turning the printer on while DSW is ON												
1	Not used (Setup prohibited)												
2	LAN board EEPROM initialization (Initializing configuration)												
3	Print of configuration (Printing configuration details on a label)												
4	Print of self-diagnosis (Printing diagnostic result of the board)												

7.5 LOCAL AREA NETWORK (LAN) ETHERNET (Cont'd)

7.5.1 Basic Specifications (Cont'd)

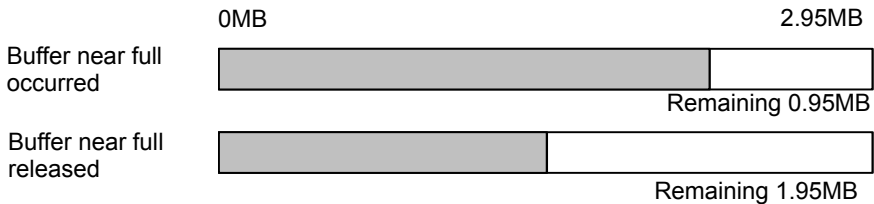
<p>Communication setup</p>	<p>The following communication settings are available in the Interface Mode of the printer.</p> <table border="1" data-bbox="518 414 1380 739"> <thead> <tr> <th>Item</th> <th>Setting range</th> </tr> </thead> <tbody> <tr> <td>Protocol</td> <td>STATUS3 STATUS4 (Cyclic response mode) STATUS4 (ENQ response mode) STATUS5</td> </tr> <tr> <td>IP address</td> <td>0.0.0.0 ~ 255.255.255.255</td> </tr> <tr> <td>Subnet mask</td> <td>0.0.0.0 ~ 255.255.255.255</td> </tr> <tr> <td>Gateway address</td> <td>0.0.0.0 ~ 255.255.255.255</td> </tr> </tbody> </table> <p>* IP address, Subnet mask, Gateway address are settable through [Admin Manager], the utility of attached CD-ROM. In this case, each setting value is saved to the interface board directly. Go to [Configuration] of the Interface Mode to enable the setup by either the Interface Mode or [Admin Manager].</p>	Item	Setting range	Protocol	STATUS3 STATUS4 (Cyclic response mode) STATUS4 (ENQ response mode) STATUS5	IP address	0.0.0.0 ~ 255.255.255.255	Subnet mask	0.0.0.0 ~ 255.255.255.255	Gateway address	0.0.0.0 ~ 255.255.255.255
Item	Setting range										
Protocol	STATUS3 STATUS4 (Cyclic response mode) STATUS4 (ENQ response mode) STATUS5										
IP address	0.0.0.0 ~ 255.255.255.255										
Subnet mask	0.0.0.0 ~ 255.255.255.255										
Gateway address	0.0.0.0 ~ 255.255.255.255										
<p>Maximum receive buffer capacity</p>	<p>2.95MB</p>  <p>0MB 2.95MB</p> <p>Buffer near full occurred Remaining 0.95MB</p> <p>Buffer near full released Remaining 1.95MB</p>										

7.6 WIRELESS LAN ETHERNET

7.6.1 Basic Specifications

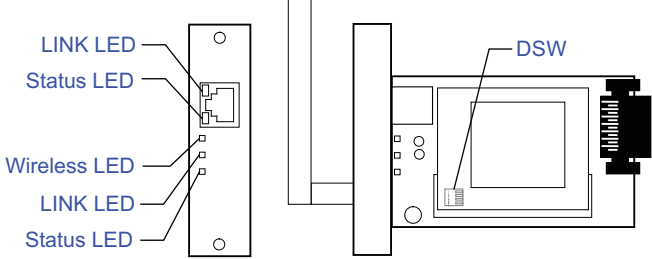
<p>Interface connector</p>	 <p style="text-align: center;">Wireless LAN Interface board</p> <p>Cable type: For 10BASE-T and 100BASE-TX Cable length: 100m or less</p>																					
<p>Link/Status LED</p>	<p>Status LED lights up when establishing the LINK with Ethernet device or when receiving the packets. The LINK is established by Auto Negotiation.</p> <table border="1" data-bbox="518 862 1380 1131"> <thead> <tr> <th>Connector built-in LED</th> <th>Color</th> <th>Conditions</th> </tr> </thead> <tbody> <tr> <td>LINK</td> <td>Green</td> <td>Blinks: Waiting for the link detection of wired LAN On: Establishing the link by wired LAN Off: Wired LAN not in use</td> </tr> <tr> <td>STATUS</td> <td>Orange</td> <td>Not in use (Off)</td> </tr> </tbody> </table> <table border="1" data-bbox="518 1176 1380 1523"> <thead> <tr> <th>LED</th> <th>Color</th> <th>Conditions</th> </tr> </thead> <tbody> <tr> <td>LINK</td> <td>Green</td> <td>Blinks: Waiting for the link detection of wireless LAN On: Establishing the link by wireless LAN Off: Wireless LAN not in use</td> </tr> <tr> <td>STATUS</td> <td>Orange</td> <td>Blinks: Lights up for a given length of time when receiving packets by wireless LAN</td> </tr> <tr> <td>Wireless</td> <td>Green</td> <td>Blinks: Ad hoc mode On: Infrastructure mode</td> </tr> </tbody> </table>	Connector built-in LED	Color	Conditions	LINK	Green	Blinks: Waiting for the link detection of wired LAN On: Establishing the link by wired LAN Off: Wired LAN not in use	STATUS	Orange	Not in use (Off)	LED	Color	Conditions	LINK	Green	Blinks: Waiting for the link detection of wireless LAN On: Establishing the link by wireless LAN Off: Wireless LAN not in use	STATUS	Orange	Blinks: Lights up for a given length of time when receiving packets by wireless LAN	Wireless	Green	Blinks: Ad hoc mode On: Infrastructure mode
Connector built-in LED	Color	Conditions																				
LINK	Green	Blinks: Waiting for the link detection of wired LAN On: Establishing the link by wired LAN Off: Wired LAN not in use																				
STATUS	Orange	Not in use (Off)																				
LED	Color	Conditions																				
LINK	Green	Blinks: Waiting for the link detection of wireless LAN On: Establishing the link by wireless LAN Off: Wireless LAN not in use																				
STATUS	Orange	Blinks: Lights up for a given length of time when receiving packets by wireless LAN																				
Wireless	Green	Blinks: Ad hoc mode On: Infrastructure mode																				

7.6 WIRELESS LAN ETHERNET (Cont'd)

7.6.1 Basic Specifications (Cont'd)

<p>DSW</p>	<p>DSW is a maintenance switch to initialize the configuration saved on the wireless LAN board, to print the configuration, and to set wireless LAN communication mode.</p> <p><Important></p> <p>1) Make sure to set all the DSW to “OFF” when you use the printer. 2) Make sure to set [DSW1] to “OFF”.</p> <table border="1" data-bbox="520 591 1380 981"> <thead> <tr> <th>DSW</th> <th>Operation when turning the printer on while DSW is ON</th> </tr> </thead> <tbody> <tr> <td>1</td> <td>Not used (Setup prohibited)</td> </tr> <tr> <td>2</td> <td>LAN board EEPROM initialization (Initializing configuration)</td> </tr> <tr> <td>3</td> <td>Print of self-diagnosis (Prints the examination result of board on a label) Print of configuration (Prints configuration details such as an address)</td> </tr> <tr> <td>4</td> <td>Wireless mode switching (OFF: Ad hoc / ON: Infrastructure)</td> </tr> </tbody> </table>	DSW	Operation when turning the printer on while DSW is ON	1	Not used (Setup prohibited)	2	LAN board EEPROM initialization (Initializing configuration)	3	Print of self-diagnosis (Prints the examination result of board on a label) Print of configuration (Prints configuration details such as an address)	4	Wireless mode switching (OFF: Ad hoc / ON: Infrastructure)						
DSW	Operation when turning the printer on while DSW is ON																
1	Not used (Setup prohibited)																
2	LAN board EEPROM initialization (Initializing configuration)																
3	Print of self-diagnosis (Prints the examination result of board on a label) Print of configuration (Prints configuration details such as an address)																
4	Wireless mode switching (OFF: Ad hoc / ON: Infrastructure)																
<p>Interface selection</p>	<p>Wireless LAN interface and the LAN interface are provided as a combo board. Turn on the printer without connecting the LAN cable.</p>																
<p>Communication setup</p>	<p>The following communication settings are available in the Interface Mode of the printer.</p> <table border="1" data-bbox="520 1196 1380 1738"> <thead> <tr> <th>Item</th> <th>Setting range</th> </tr> </thead> <tbody> <tr> <td>Protocol</td> <td>STATUS3 STATUS4 (Cyclic response mode) STATUS4 (ENQ response mode) STATUS5</td> </tr> <tr> <td>IP address</td> <td>0.0.0.0 ~ 255.255.255.255</td> </tr> <tr> <td>Subnet mask</td> <td>0.0.0.0 ~ 255.255.255.255</td> </tr> <tr> <td>Gateway address</td> <td>0.0.0.0 ~ 255.255.255.255</td> </tr> <tr> <td>Communication mode</td> <td>802.11 Ad hoc Infrastructure</td> </tr> <tr> <td>SSID</td> <td>Optional alphanumeric character string (Up to 32 characters)</td> </tr> <tr> <td>Channel</td> <td>01 ~ 14</td> </tr> </tbody> </table> <p>* IP address, Subnet mask, Gateway address are settable in [Admin Manager], the utility of attached CD-ROM, and communication mode is settable by the DSW of interface board. In this case, each setting value is saved to the interface board directly. Go to [LAN Configuration] of Interface Mode to enable the setup either by the one mentioned above or by the Interface Mode.</p>	Item	Setting range	Protocol	STATUS3 STATUS4 (Cyclic response mode) STATUS4 (ENQ response mode) STATUS5	IP address	0.0.0.0 ~ 255.255.255.255	Subnet mask	0.0.0.0 ~ 255.255.255.255	Gateway address	0.0.0.0 ~ 255.255.255.255	Communication mode	802.11 Ad hoc Infrastructure	SSID	Optional alphanumeric character string (Up to 32 characters)	Channel	01 ~ 14
Item	Setting range																
Protocol	STATUS3 STATUS4 (Cyclic response mode) STATUS4 (ENQ response mode) STATUS5																
IP address	0.0.0.0 ~ 255.255.255.255																
Subnet mask	0.0.0.0 ~ 255.255.255.255																
Gateway address	0.0.0.0 ~ 255.255.255.255																
Communication mode	802.11 Ad hoc Infrastructure																
SSID	Optional alphanumeric character string (Up to 32 characters)																
Channel	01 ~ 14																

7.6 WIRELESS LAN ETHERNET (Cont'd)

7.6.1 Basic Specifications (Cont'd)

Wireless access	1) Standard	IEEE802.11b/11g
	2) Data transfer method (Auto switching)	11b : 11/5.5/2/1bps 11g : 54/48/36/24/18/12/11/9/6/5.5/2/1Mbps
	3) Communication distance	Indoor (Max. 100m), Outdoor (Max. 240m) Use environment affects the communication distance.
	4) Frequency band	2.4GHz (2.412 ~ 2.4835GHz)
	5) Channel	11b : 1 ~ 14ch (Default: 11) 11g : 1 ~ 13ch (Default: 11)
	6) SSID	Optional alphanumeric character string (up to 32-chars)
	7) Authentication method	Open System (802.1x authentication is selectable) Shared Key WPA(PSK(Pre-Shared Key), 802.1x authentication) 802.1x(EAP-TLS, LEAP authentication selectable)
Wireless access	8) Encryption method	None WEP (Open System, Shared Key, 802.1x authentication) TKIP (WPA-PSK, WPA-802.1x authentication) AES (WPA-PSK, WPA-802.1x authentication)
Maximum receive buffer capacity	2.95MB	

7.7 LAN AND WIRELESS LAN ETHERNET SPECIFICATIONS

7.7.1 Software Specifications

Protocol	TCP/IP
Network layer	ARP, RARP, IP, ICMP
Session layer	TCP, UDP
Application layer	LPD, FTP, TELNET, BOOTP, DHCP, HTTP

Notes

- Send the print data by LPR and FTP of TCP/IP and dedicated socket protocol.
- Use socket connection to get the printer status.

7.7.2 TCP/IP Specifications

In TCP/IP protocol environment, LPD and FTP are provided for printing. TELNET is provided for the setup of various variables, and ARP, RARP and BOOTP/DHCP for the setup of IP address are available. In WindowsNT4.0, Windows95/98, WindowsMe, Windows2000, WindowsXP, and WindowsVista environments, IP address and variables can be set using the [Admin Manager] in the utility of attached CD-ROM. For more information about [Admin Manager], refer to [Network Utility] in the CD-ROM.

In socket connection, the printing operation and the status are monitored by using [Printer Driver] and [Status Monitor] in the CD-ROM. In this case, multiple connections cannot be established at the same time. For more information about [Printer Driver] and [Status Monitor], refer to the instructions in the CD-ROM.

WindowsNT4.0, Windows2000, WindowsXP and WindowsVista operating systems support LPD of TCP/IP that enables you to print; however, Windows95/98 and WindowsMe are not configured with LPD. In order to perform printing operation, off-the-shelf printing software is required.

7.7.3 LPD Specifications

LPD protocol complies with RFC1179 and handles the list of logical printer name as queue name such as lp, sjis and euc. In addition, a banner page can be printed by a proper setup.

Queue name	Kanji filter applied	Input Kanji code
lp	Not available	N/A
sjis	Available	Shift JIS
euc	Available	EUC

When sending a job by LPR, the transmission order of data file/control file within the job does not affect the printing operation. In addition, if the banner page is specified, it will be added to each data file.

Notes

- A job deletion by LPR is not supported.
- LPD can be used for STATUS4 only

7.7.4 FTP Specifications

FTP protocol complies with RFC959 and handles the list of logical printer name as transfer directory. File transfer to this directory executes print operation. Note that it is possible to specify ASCII(A), BINARY(I), and TENEX(L8) as transfer modes, although mode difference is dependent on the client side.

In addition, a banner page can be printed with a proper setup.

There are three directory names such as lp, sjis and euc.

Queue name	Kanji filter applied	Input Kanji code
lp	Not available	N/A
sjis	Available	Shift JIS
euc	Available	EUC

7.7 LAN AND WIRELESS LAN ETHERNET SPECIFICATIONS (Cont'd)

7.7.5 TELNET Specifications

TELNET complies with RFC854. This consists of an interactive menu form, and it enables you to change and refer internal setup and to display status. To change the setting details, enter 'root' user name and password at the time of login. Default value of root password is set to null (line feed only).

<Example of TELNET command>

In MS-DOS command prompt, type in [TELNET xxx.xxx.xxx.xxx (IP address)] and enter user name and password to advance to the display below.

For Local Area Network (LAN) Ethernet

```
SATO SATO Series Ver 1.2.0.0 TELNET server.
SATO CORPORATION Copyright(C) 1999-2002
login: root
'root' user needs password to login
password:
User 'root' logged in
```

No.	Item	Value	(level.1)
1	Setup TCP/IP		
2	Setup printer port		
3	Display status		
96	Reset to factory set		
97	Reboot		
98	Quit setup		
99	Exit setup		
	Please select(1-99)?		

For Wireless LAN Ethernet

```
SATO SATO Series WL Ver 1.0.0 TELNET server.
SATO CORPORATION Copyright(C) 1999-2002
login: root
'root' user needs password to login
password:
User 'root' logged in
```

No.	Message	Value	(level.1)
1	Setup TCP/IP		
2	Setup Wireless LAN		
3	Setup printer port		
4	Display status		
96	Reset to factory set		
97	Reboot		
98	Quit setup		
99	Exit setup		
	Please select(1-99)?		

For the detailed settings of [1:Setup TCP/IP], refer to [7.7.6 Setting/Displayed Items].

7.7 LAN AND WIRELESS LAN ETHERNET SPECIFICATIONS (Cont'd)

7.7.6 Setting/Displayed Items

The following table shows the settings and referable sections as well as various variables.

TCP/IP related settings

Variable identifier	Setting range	Default (Factory setting)
TCP/ IP protocol	ENABLE/ DISABLE	ENABLE
IP address	0.0.0.0 ~ 255.255.255.255	0.0.0.0 (Externally obtained)
Subnet mask	0.0.0.0 ~ 255.255.255.255	0.0.0.0 (Derived from IP address)
Gateway address	0.0.0.0 ~ 255.255.255.255	0.0.0.0 (Invalid)
RARP protocol	ENABLE/ DISABLE	ENABLE
BOOTP protocol	ENABLE/ DISABLE	ENABLE
ROOT password	Up to 7 random alphanumeric characters	NULL (No password)

Printer port-related settings

Variable identifier	Setting range	Default (Factory setting)
BOJstring	Optional string and special character string consist of max. 31 characters* ¹	NULL
EOJstring	Optional string and special character string consist of max. 31 characters* ¹	NULL
BOJstring(KANJI)	Optional string and special character string consist of max. 31 characters* ¹	NULL
EOJstring(KANJI)	Optional string and special character string consist of max. 31 characters* ¹	NULL
PRINTER type	ASCII, SJIS, EUC, LIPS, PR201 PR201-E, ESC/P, ESC/P-E, ESC/ Page, FMPR, N5263, J31, PS	ASCII
TAB size	0-16	8
Page width	0-255	0
Page length	0-255	0
Banner output	NO/YES	NO

*¹Alternative terms in the table below can be used by a special character string.

All terms	Corresponding code	HEX
¥b	Back space code	08
¥t	Tab code	09
¥n	Linefeed code	0D
¥v	Vertical tab code	0B
¥r	Return code	0A
¥f	Page break code	0C
¥xnn	HEX code described in nn	nn
¥"	" mark	22
¥¥	¥mark	5C

7.7 LAN AND WIRELESS LAN ETHERNET SPECIFICATIONS (Cont'd)

7.7.7 Wireless LAN Setting

Variable identifier	Setting range	Default (Factory setting)
SSID	Optional alphanumeric character (Up to 32 characters)	"NULL"
Channel	1 ~ 14	11
Use WEP	DISABLE/64 bits/128 bits	DISABLE
WEP Key	Hexadecimal digit 64 bits?: 10 digits 128 bits : 26 digits	"00000000000000000000000000000000"

For each communication mode and validity

	Ad hoc	802.11 Ad hoc	Infrastructure
SSID	x	o	o
Channel	o	o	x
Use WEP	o	o	o

- *1. Communication mode is set by DSW.
- *2. If there is a group with the same SSID already existing within the communication range, the value used by the group will be assigned to Channel.
- *3. If SSID is set to null (""), it is possible to connect to the equipment nearby without specifying SSID.
- *4. If SSID is set to "ANY", it tries to connect to SSID "ANY".

7.8 EXTERNAL SIGNAL INTERFACE (EXT)

The external signal interface is designed to connect the printer to an optional stacker or rewinder.

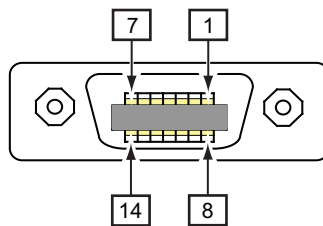

EXT External Signal Connector Pin Assignments

7.8 EXTERNAL SIGNAL INTERFACE (EXT) (Cont'd)

7.8.1 Basic Specifications

Connector	14-pin external signal interface
Input/Output circuit diagram	<p>14-PIN type Input/Output connection example</p>
Signal level	High level : +2.4~+5.0V Low level : +0.0~+0.4V

7.8.2 Pin Assignments

Pin No.	Signal name	Description	I / O	Level	Electrical condition (voltage, electric current [MAX])
1	—	—	—	—	—
2	GND	SIGNAL GROUND	—	—	—
3	REWINDER	Outputs when detecting RIBBON END	Output	Low	5V 400mA
4	—	—	—	—	—
5	FULL SWITCH	Prints a single label by every input of this signal	Input	Low	High: High impedance Low : -15mA or more, 0V
6	STACKER	Outputs signal every time the printer issues a single label	Output	Low	5V 400mA
7	—	—	—	—	—
8	—	—	—	—	—
9	—	—	—	—	—
10	—	—	—	—	—
11	—	—	—	—	—
12	+24V	—	—	—	2A
13	+5V	—	—	—	500mA
14	—	—	—	—	—

This page is intentionally left blank

8

APPENDIX

The following information is provided:

- 8.1 Optional Accessories - Stacker
- 8.2 Optional Accessories - Label Rewinder
- 8.3 Optional Accessories - Keypad
- 8.4 Positions of Sensors and Options
- 8.5 Base Reference Point
- 8.6 Shifting Motion of Base Reference Point
- 8.7 Jump Hole
- 8.8 Tag Sorting Method
- 8.9 Paper End
- 8.10 Ribbon End
- 8.11 Ribbon Near End
- 8.12 Media Size Check
- 8.13 Perforated Line
- 8.14 Information on Media when using Cutter

8.1 OPTIONAL ACCESSORIES - STACKER

The Integrated Stacker option can stack up to 500 tags at the maximum print speed of the TG3 series printer. It obtains its power through the **EXT** Accessory port connector on the rear of the printer.

8.1.1 Parts of Stacker Unit

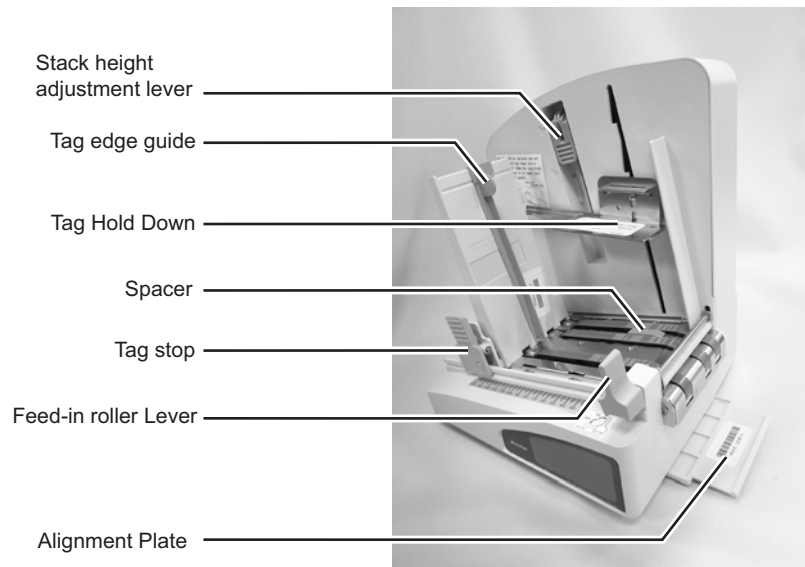

The Stacker unit consists of the following major components:

- **Stacker** - The Stacker collects and stacks the tags as they are printed and cut.
- **Tag Stop** - The Tag Stop is adjusted to the length of the tag. While pressing the clip-like lock, slide the Tag stop to adjust for the length of the tags being stacked. A scale is provided for reference when making this adjustment.
- **Tag Edge Guide** - The Tag Edge Guide should be adjusted for the width of the tag. It is held in place after adjustment by friction teeth on the Tag Stop.
- **Tag Hold Down** - The Tag Hold Down keeps the ejected tag in place. Additional **Tag Weight** plate can be attached when using tag with 90mm (3.54") or more in length.
- **Spacer** - Attach the spacer for laminated tags and vanish coated tags longer than or equal to 90mm (3.54").
- **Stack height adjustment lever** - Lift up the Stack height adjustment lever to adjust the maximum stacking height of the tags. Flip down the lever to lock its position. When the tags reached the specified height, the printer will stop printing.
- **Feed-in roller Lever** - Always set the Feed-in roller Lever up whenever you use the stacker. Press down only when printing label and by pass the stacker.
- **Alignment Plate** - The Alignment Plate is used to maintain proper alignment between the printer and the Stacker. Slot in the plate to the base of the stacker.

8.1 OPTIONAL ACCESSORIES - STACKER (Cont'd)

8.1.2 To install the Stacker

1. Position the Stacker with the alignment plate attached, to the front of the printer and slot the other end of alignment plate to the base of printer.



2. Connect the built-in cable from the Stacker to the **EXT** connector on the printer.

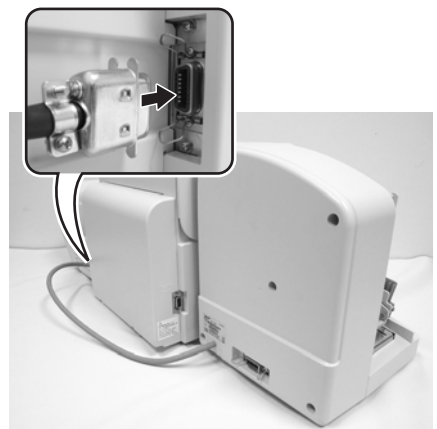

3. Adjust the **Tag Stop** for the length of the tag.
4. Adjust the **Tag Edge Guide** to the width of the tag.
5. Turn the printer on and make sure the cutter is enabled and the tags aligned for printing.

Note:

If the tag sensors are not aligned properly, the printer feeds out a length of tag stock without cutting it, as it is attempting to determine the tag pitch (length). Temporarily move the Stacker unit to one side if this occurs, until the sensors are correctly set and the tags are at the proper position. See **Section 2.3 Loading Media** for instructions on loading and **Section 2.4 Media Type selection** for instructions on Tag sensor setting.

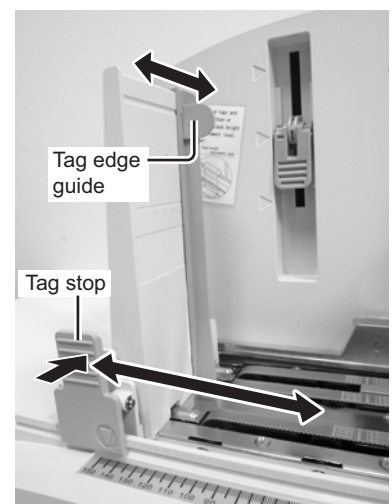

6. Send the print job to the printer and let it cut and stack a few tags. The temporarily stop the printer by pressing the **ONLINE** button and check to make sure the tags are being stacked under the **Tag Hold Down** and that the **Tag Stop** and **Tag Edge Guide** are properly set.
7. When proper operation has been verified, place the printer back ON LINE by pressing the **ONLINE** button again to finish the print job.
8. The printer will automatically stop and go OFFLINE when the Stacker is full. When this happens, remove the tags and finish the print job by pressing the **ONLINE** button to place the printer back ON LINE.

8.2 OPTIONAL ACCESSORIES - LABEL REWINDER

The rewinder is an external unit that allows for labels to be rewound in rolls up to 107mm (4.2") in diameter. The rewinder derives its power using a built-in cable connected directly to the printer's **EXT** connector. The rewinder facilitates the rewinding of labels from the printer and subsequently unwinds the media for use with applicators.

8.2.1 To install the Label Rewinder

1. Slot in the Alignment plate to the base of the rewinder.
2. Position the Label rewinder with the alignment plate attached, to the front of the printer and slot the other end of alignment plate to the base of printer. (The Rewind spindle of the rewinder should be positioned away from the printer.)
3. Connect the built-in cable from the Rewinder to the **EXT** connector at the rear of the printer.
4. On the Rewinder, remove the metal clamp from the Rewind Spindle.
5. Feed the lead end of the label stock under the first spindle and onto the Rewind Spindle. Feed the stock around the spindle once, then replace the metal clamp over the label stock. Wind another revolution to ensure the labels are secure on the spindle.
6. Power on the printer.

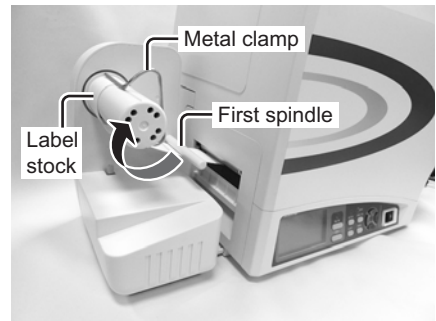

8.3 OPTIONAL ACCESSORIES - KEYPAD

The optional keypad can be connected to the TG3 Series printer with the **Keypad** connection terminal, thus providing a stand-alone function.

1. Make sure that power cable is not connected to the printer.
2. Connect the cable from the optional Keypad device to the **Keypad** connection terminal at the left side of the **Media ejection slot** of the printer.

Note:

Make sure the connector is correctly oriented. Secure the printer with one hand, and insert the connector firmly.

3. Set the printer for use with the connected device. Refer to **Section 3.7 Interface Mode** and perform the procedures to set the **Keypad CONNECT** to **ENABLE**.

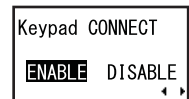

8.4 POSITIONS OF SENSORS AND OPTIONS

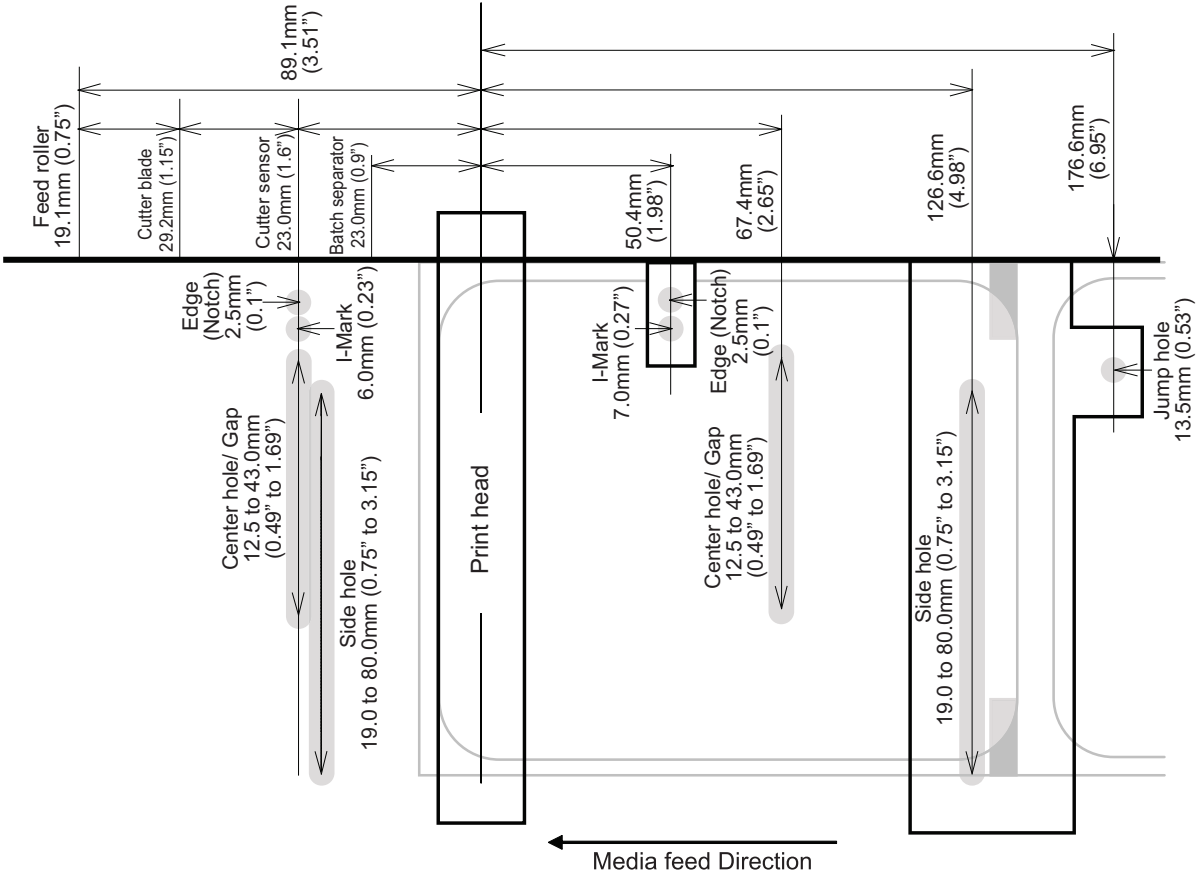

Only center hole sensor and Gap sensor are in common use. There is no interference among sensors shown above.

8.5 BASE REFERENCE POINT

The base reference point is the point at which one determines the print and cut positions.

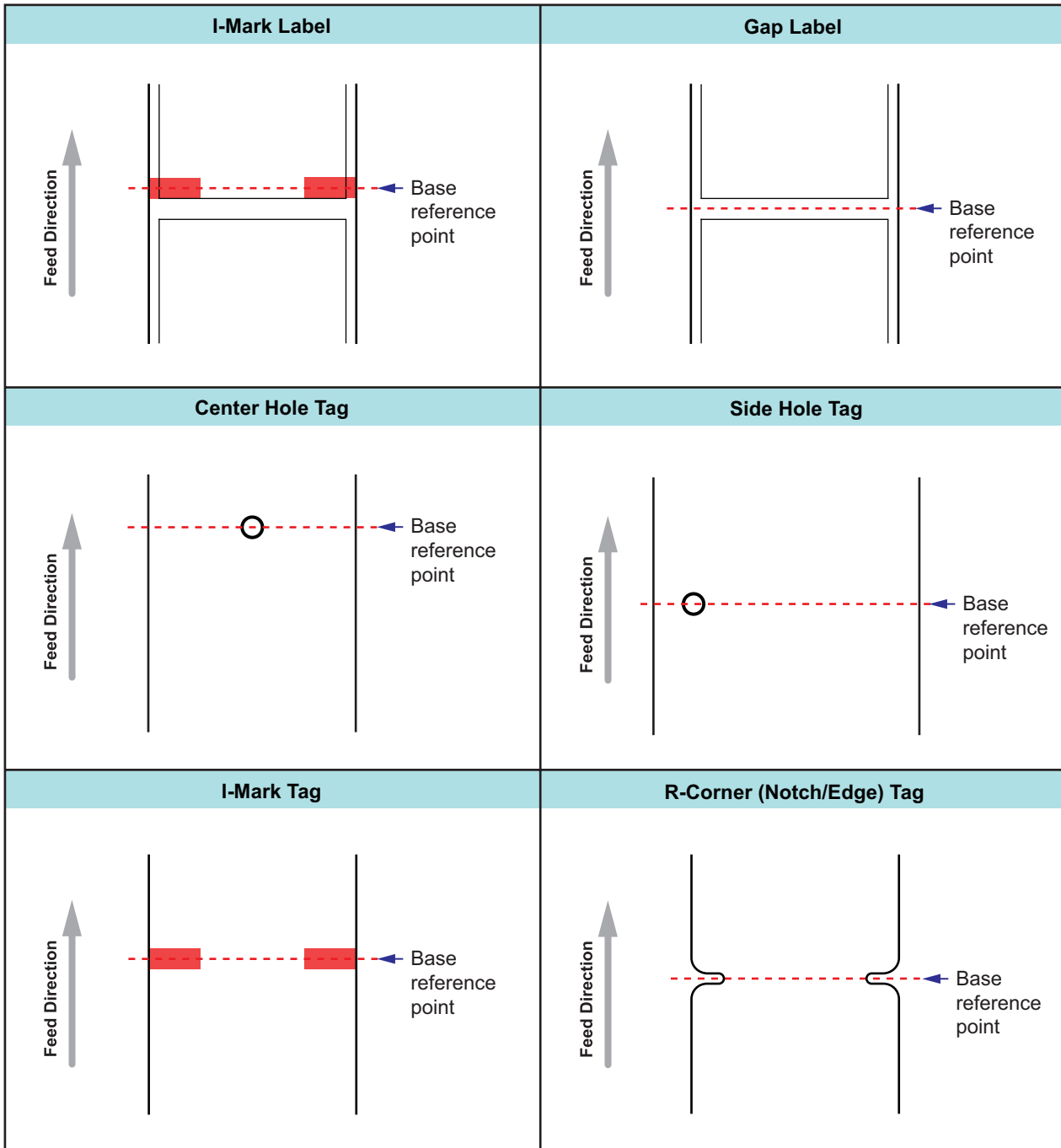

The center of each mark or hole is defined as the base reference point.
 In Service Mode, using the offset function for each label and tag will eliminate an unprintable area.

8.6 OFFSET POSITION ADJUSTMENT

The offset function (print, cut and backfeed) of the printer are as follows.

8.5.1 Adjustment of Print Position

Adjustment screen Mode: Pitch Position +/-3.75mm (0.15") for all media types
 Online command (ESC #) +/-50mm (2") for each media when received
 Service Mode: Pitch Offset +/-99dot for each media

8.5.2 Adjustment of Cut Position

Adjustment Mode: Offset Position +/-3.75mm (0.15") for all media
 Online command (ESC #) +/-50mm (2") for each media when received
 Service Mode: Cut Offset +/-99dot for each media
 Print or cut operation will be performed by the value of which each item is added at every single job.

The default values in Service mode

Item			TG308 (8dots/mm)	TG312 (12dots/mm)
Adjusting stop position	Tag	Center hole	+00	+00
		Side hole	+00	+00
		Edge	+00	+00
		I-Mark	-12	-18
	Label	Gap	-12	-18
		I-Mark	-36	-54
Adjusting cut position	Tag	Center hole	+00	+00
		Side hole	+00	+00
		Edge	+00	+00
		I-Mark	-12	-18
	Label	Gap	-12	-18
		I-Mark	-36	-54
		Sensor off	+00	+00
Adjusting backfeed distance	Tag	Center hole	+00	+00
		Side hole	+00	+00
		Edge	+00	+00
		I-Mark	+00	+00
	Label	Gap	+00	+00
		I-Mark	+00	+00
		Sensor off	+00	+00

8.5 OFFSET POSITION ADJUSTMENT (Cont'd)

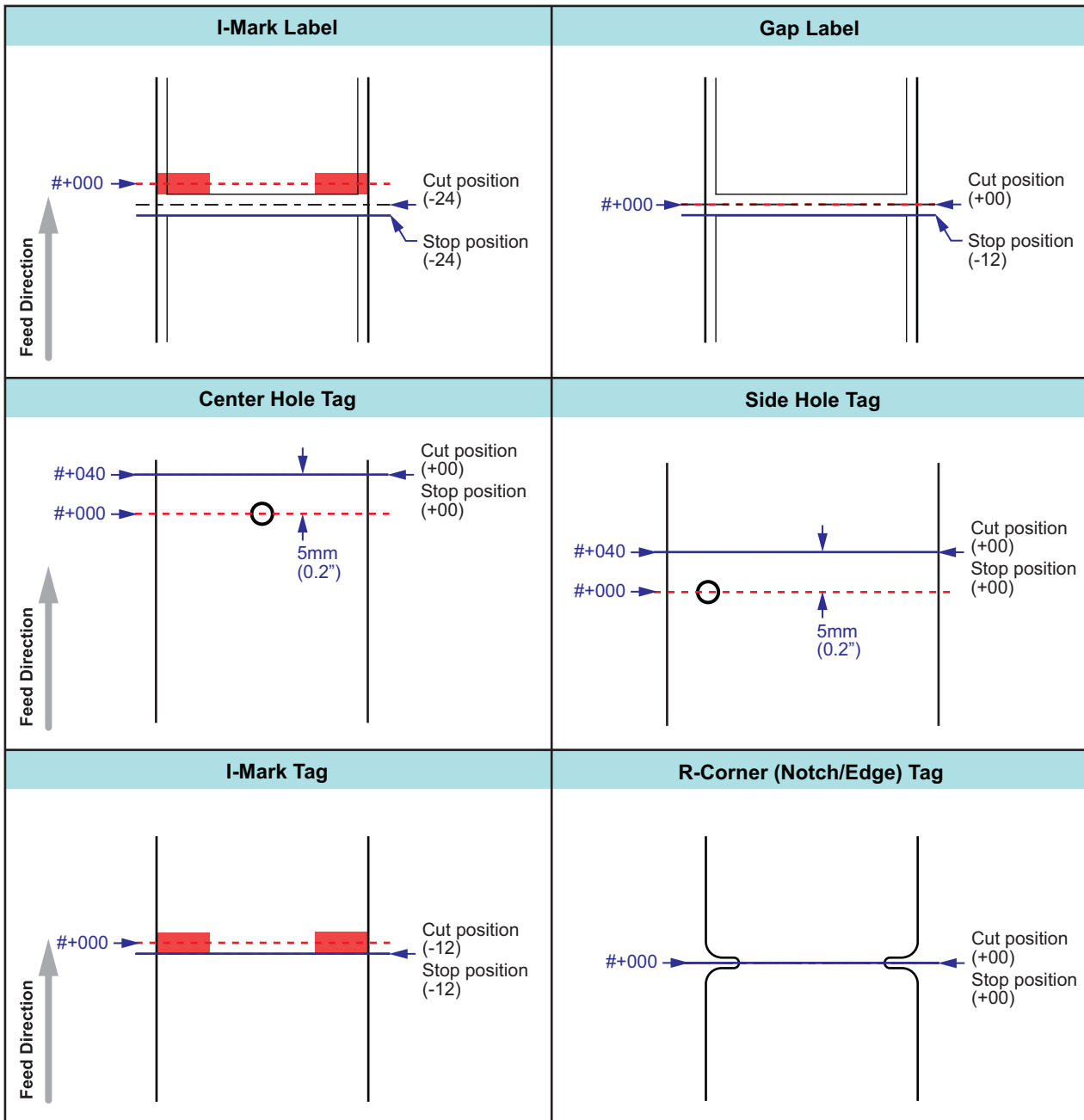

Media Type		Command (#data)	Stop position	Cut position
Tag	Center hole	#+040 (#+060)*	+00	+00
	Side hole	#+040 (#+060)*	+00	+00
	Edge	#+000	+00	+00
	I-Mark	#+000	-12 (-18)*	-12 (-18)*
Label	Gap	#+000	-12 (-18)*	+00
	I-Mark	#+000	-36 (-54)*	-24 (-36)*

* The value in parantheses() is for TG312 (12dots/mm) printer.

8.5 OFFSET POSITION ADJUSTMENT (Cont'd)

8.5.3 Adjustment of Backfeed Distance

The backfeed offset is designed to correct a backfeed distance against forward feed. It is needed when displacement of media position occurred by some slips or backlashes in paper ejection or feeding motion. The default values and its motion are described below.

Item		Default value	
Backfeed offset	Tag	Center hole	+00
		Side hole	+00
		Edge	+00
		I-Mark	+00
	Label	Gap	+00
		I-Mark	+00
		Sensor off	+00

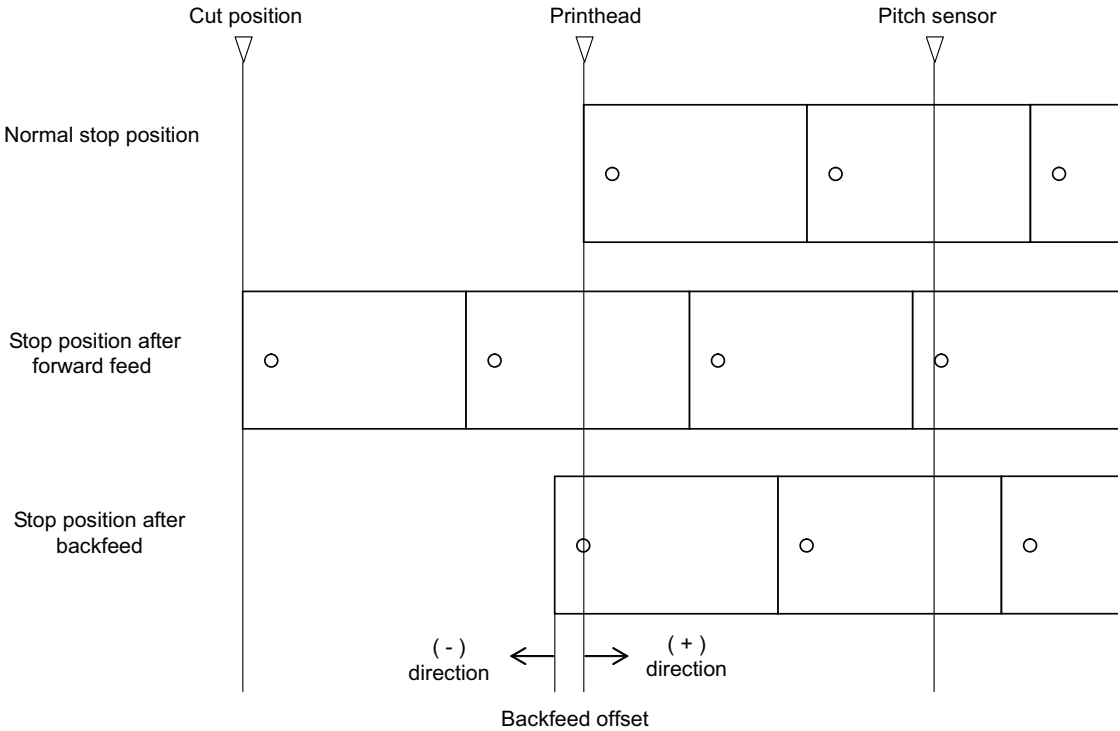

8.5 OFFSET POSITION ADJUSTMENT (Cont'd)

8.5.4 Adjustment of Media Feeding Position

A feeding error in automatic feeding function or a detection error by the media sensor may cause the incorrect print position of the first label or tag right when executing automatic feeding function. The loading offset is to correct the print position right after performing auto media feed.

Note that this adjustment is reflected in the print position right after executing auto media feed only, not for the print position after paper ejection or normal feeding motion.

The default value and its motion are described below.

Item		Default value	
Loading offset	Tag	Center hole	+00
		Side hole	+00
		Edge	+00
		I-Mark	+00
	Label	Gap	+00
		I-Mark	+00
		Sensor off	+00

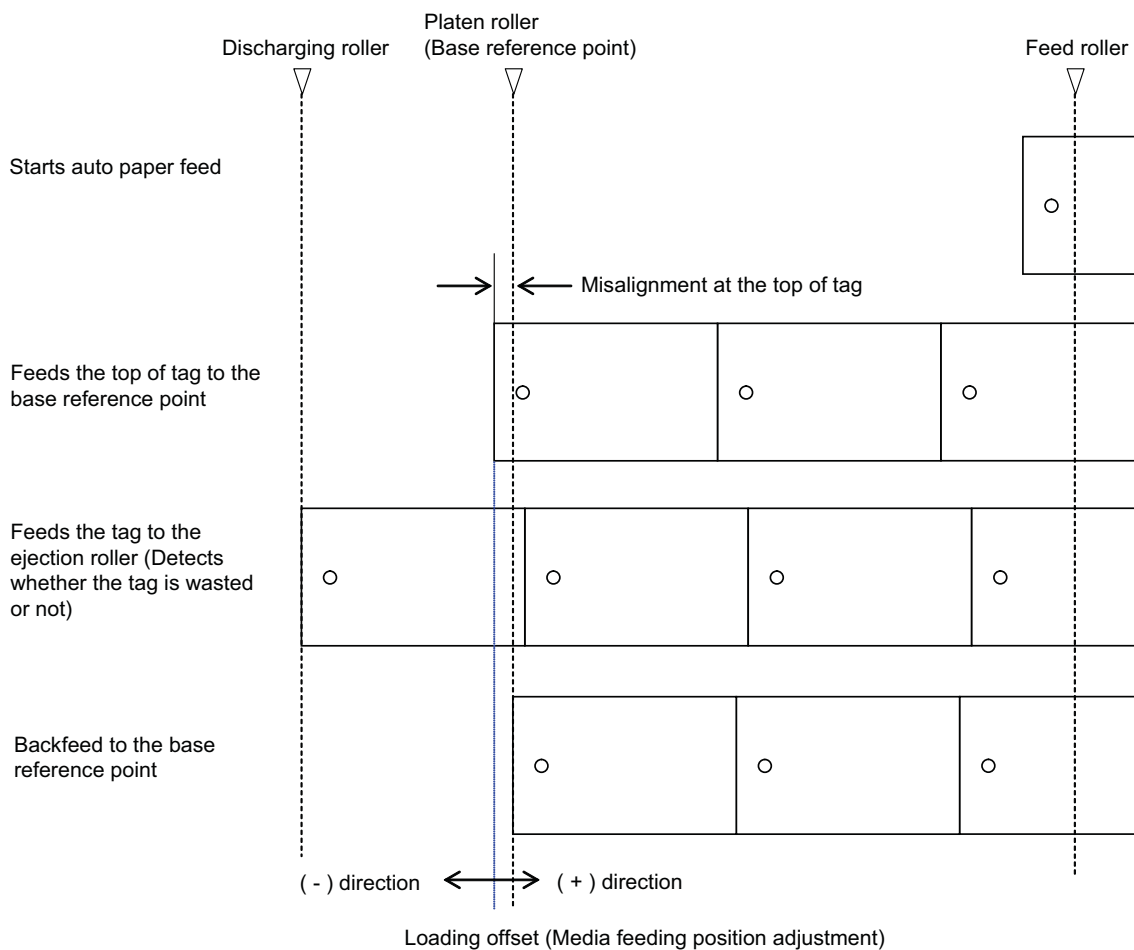

8.6 SHIFTING MOTION OF BASE REFERENCE POINT

This is the motion to shift the base reference point of printing or cutting stored in a printer to another point by the online command ESC #.

This function is used when the # data specified in the item (ESC A ~ Z) before printing is different from the default value or the #data changed previously.

With cutting motion

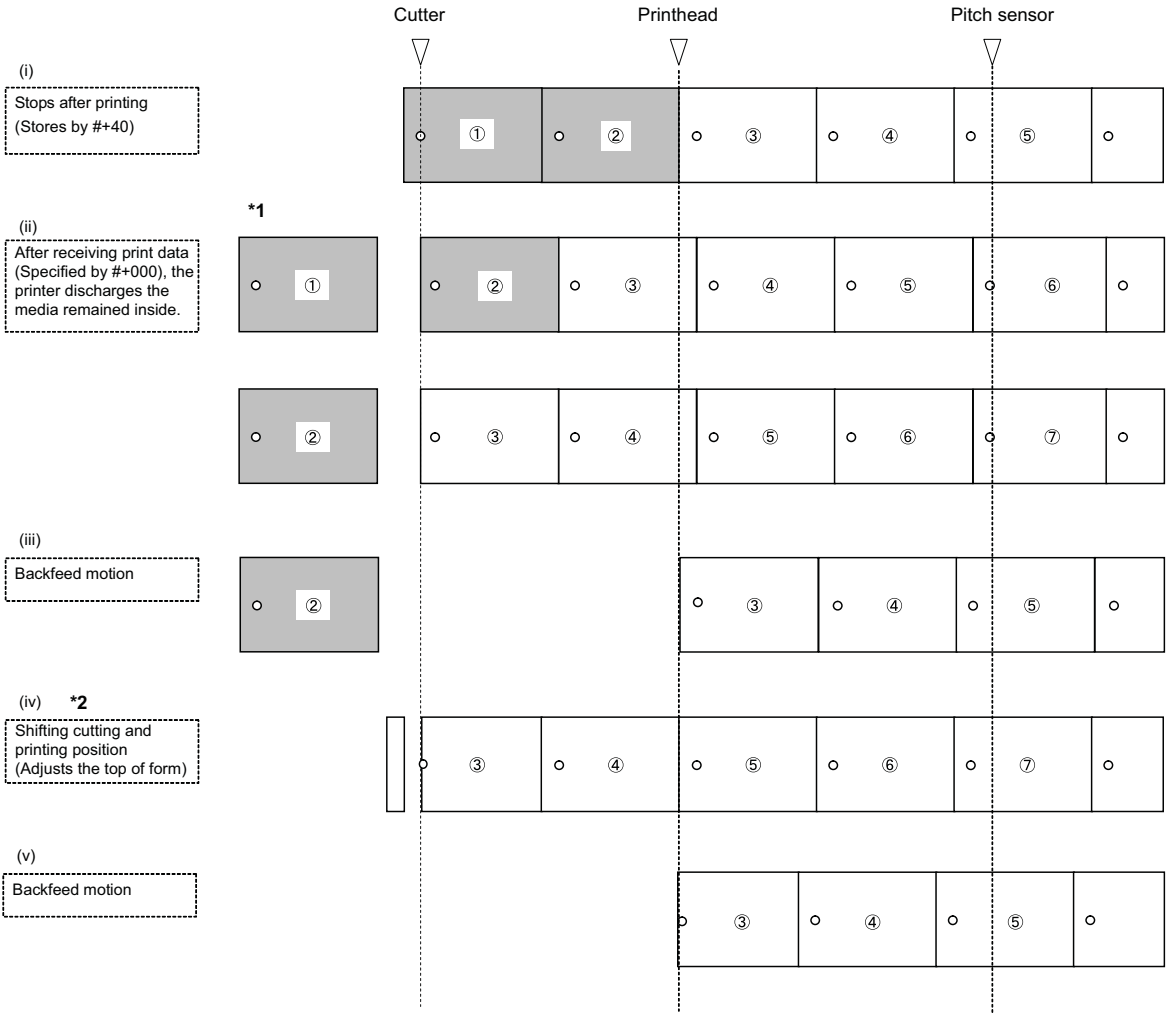

*1. For the printer without cutting motion, ① will be discharged without being cut, but ② will be cut and discharged.

*2. When the media is not remained inside, it starts from the printer motion (iv).

*3. When [ADJUST FEED ACTION] is set to "CONTINUE" in Advanced Mode, the printer will go online automatically and start issuing tags after backfeed motion is complete.

#data value is reset when power cycled, and the value changed by the # command will be valid until shutdown.

Type	Center hole tag	Side hole tag	Edge (notch) tag	I-mark tag	Gap labe	I-mark label
#data Default value	+040(+060)*	+040(+060)*	+000	+000	+000	+000

* The value in parantheses() is for TG312 (12dots/mm) printer.

8.7 JUMP HOLE

Jump hole indicates the tag (such as center hole, side hole, edge (notch) and I-mark) consists of two tags connected with a red scotch tape at the center of those two. There is a side hole at the center of connected portion.

For more details, please refer to SATO representatives.

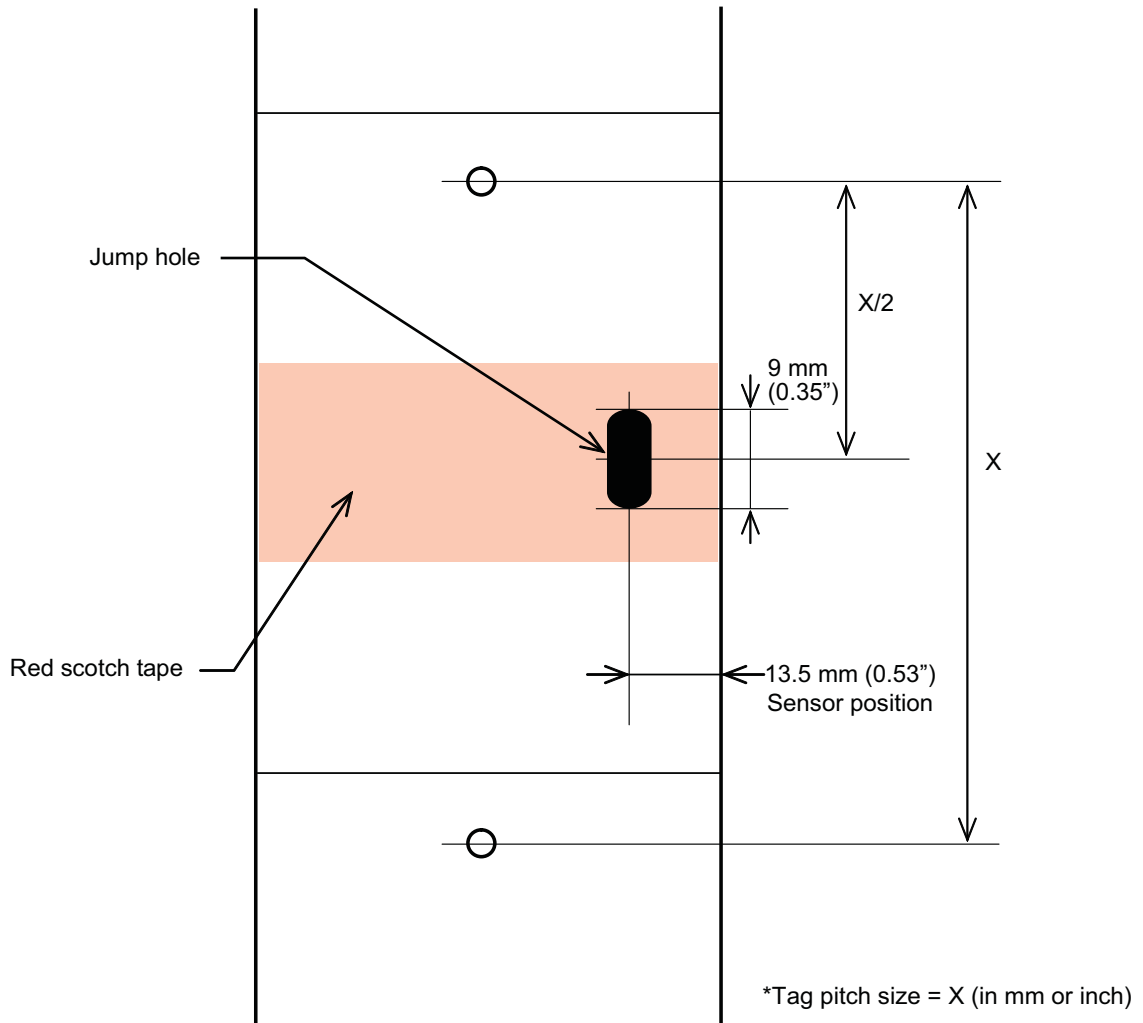

The width of jump-hole tag must be between 37mm (1.5") and 80mm (3.15"), and the pitch size must be 40mm (1.6") or more. Also, the center of jump-hole must be at "Vertical position = Pitch (X)/2 in mm or inches, Horizontal position = 13.5mm (0.53)".

For example: When the tag pitch size is 40mm (1.6"), the vertical position of jump hole is 20mm (0.8").

The tag with a jump hole is not counted as the number of print, and print operation will go on. Printed tag will be stacked and a user will remove them manually.

Nothing will be printed on the tag with a jump hole, and the printer will print normally after feeding the next tag to its start position.

Note that the data may be printed on the tag with a jump hole depending on its size. In this case, the same data will be printed on the next tag again.

The tag with a jump hole is not counted.

8.8 TAG SORTING METHOD

There are two different tag sorting methods using a batch separator (marking on the side of a tag with black ink) and a separator (changing the tag length to be cut).

8.8.1 Batch Separator

A batch separator is used for the tag (Center hole, Side hole, Edge (Notch) and I-mark) and it comes in handy to sort out the tags by its category after taking the printed tag out of the stacker. Some competitors have been making various efforts such as cutting the tag longer than usual or changing the tag direction for sorting out the printed tags. For SATO's products, black ink is applied to the side of a tag as a batch separator. Many users, deploying the batch separator, start printing the price tag after the header tag, and the header tag carries the batch separator.

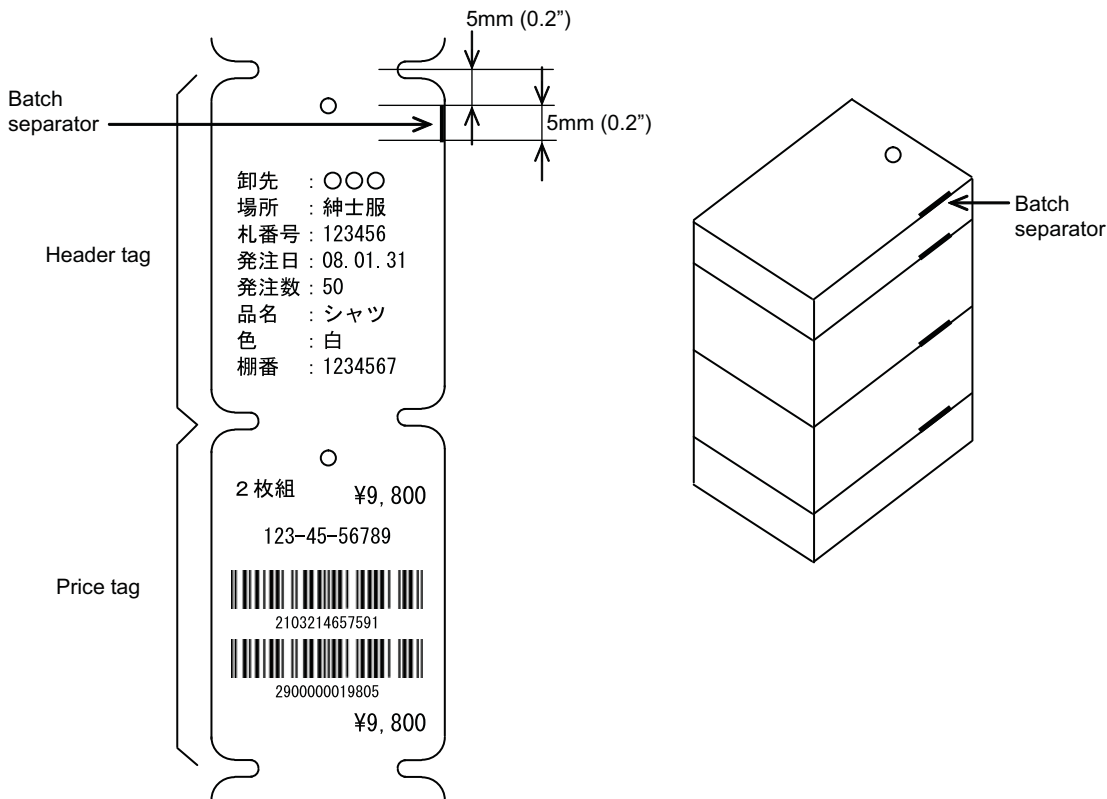

The batch separator is available only when being specified by the online command (ESC I1). When more than two tags are specified for printing, only the first tag will carry the batch separator.

Important:

Assembly position of solenoid may affect the position and size of batch separator. Please refer to the batch separator position and size in this document only as a guide. If you are sorting the labels (pitch 19mm, 0.75") continuously, the labels may not be sorted depending on the pitch sensor reading conditions. Make sure to use the labels (pitch 20mm, 0.79" or more) for this job.

8.8 TAG SORTING METHOD (Cont'd)

8.8.2 Separator

Separator is used for the tag (Center hole, Side hole, Edge (Notch) and I-mark) and it becomes available when the cutting motion is activated. The following print operation will occur when receiving the batch separator command (ESC I2) under the receive command.

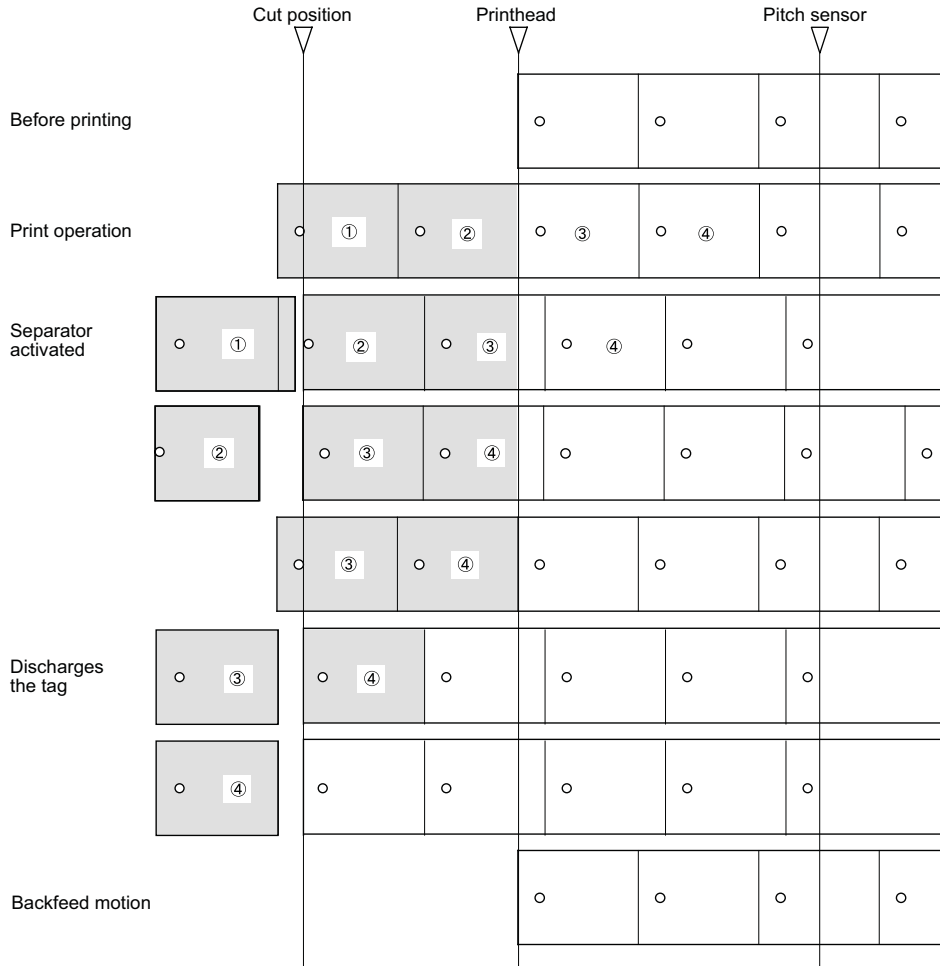

Important:

This (ESC I2) command cannot issue the second tag in long format. Please do not attempt to specify the print quantity [QTY=1] more than twice in a row. If so, a print error may occur. It is possible to specify the print of batch separator after printing the tag (QTY>=1) by the separator.

8.8 TAG SORTING METHOD (Cont'd)

8.8.2 Separator (Cont'd)

After tag discharging motion, two tags, which are about 2mm (0.08") longer and shorter than usual, will be issued.

Considering the above condition, 2mm (0.08") at the bottom of the tag will be an unprintable area when using the separator. Make sure to check the tag length when designing the tag layout.

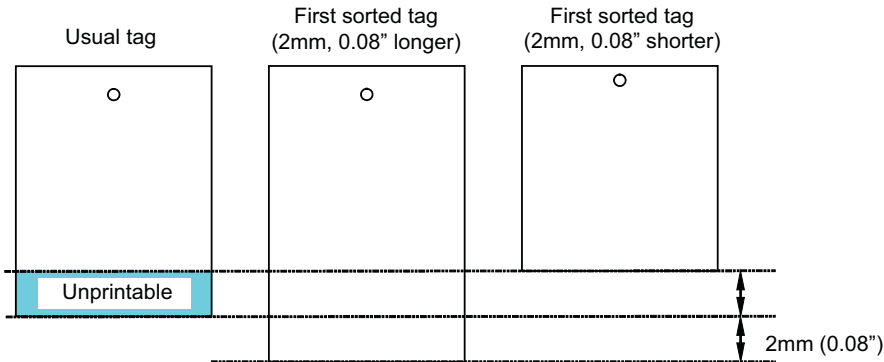

The tag will not be discharged by pressing the **EJECT** button after completing the sorting operation. If an error occurs (e.g. paper end) during sorting operation, the tags may not be sorted properly.

8.9 PAPER END

8.9.1 End Mark

An end mark will be printed on the tag when paper end error or ribbon near end error occurs. This mark enables the users to identify valid tag (QTY subtraction) and invalid tag (QTY does not change) at the time of having such print errors, and the black box will be printed on the invalid tag.

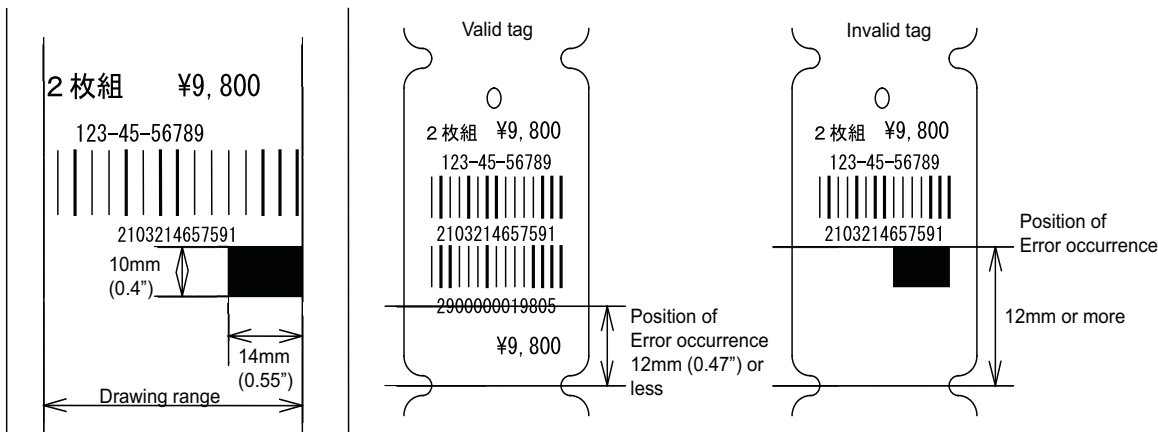

When the cutting motion is activated, an end mark will be printed regardless of position where an error occurred (within 12mm, 0.47").

This 12mm (0.47") is a designed value, therefore, an end mark may or may not be printed depending on the tag size and the data to be printed.

8.9 PAPER END (Cont'd)

8.9.2 Paper End Error Detection

There are two ways to detect paper end error using the jump hole sensor and the media size.

Detection by Jump Hole Sensor

When the jump hole sensor detects no tag for 84mm (3.3"), a paper end error will be detected. Then the printer will print an end mark on the tag and stop the print operation after cutting a valid tag.

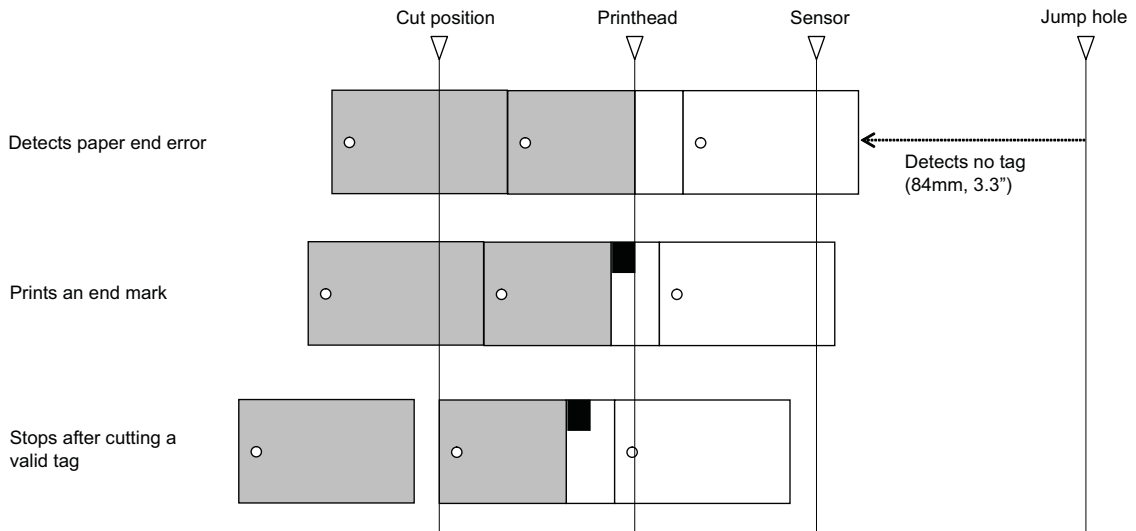

Detection by Tag Size

The size of tag previously printed and the one currently being printed will be compared. When there is +/- 5mm (0.2") difference in size between those two tags, the printer will detect a paper end error and stop the print operation after cutting a valid tag. If there is no valid tag, the print operation will be stopped by the detection of an error.

Note that an end mark will not be printed on the tag if detecting an error related to tag size.

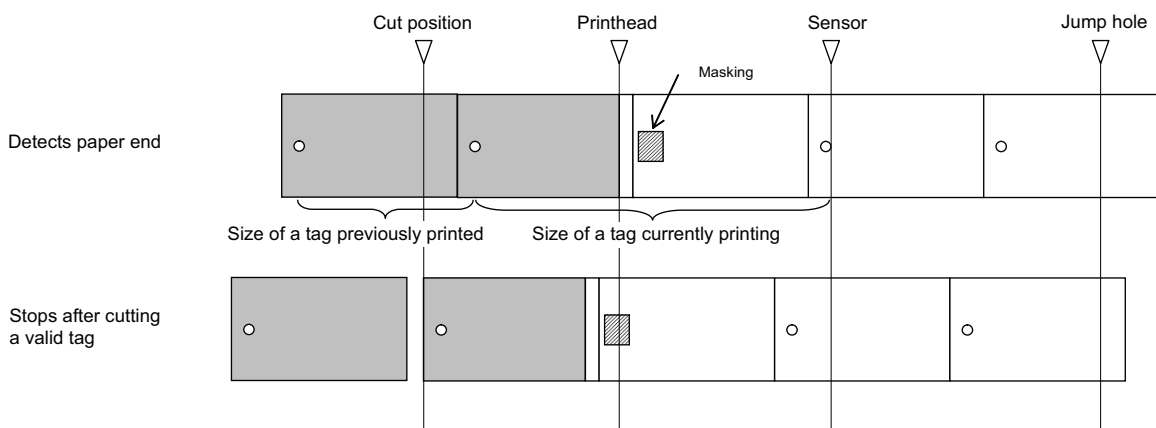

Note:

As for the tag (Center hole, Side hole, Edge (Notch)), there is 300mm (11.8") or more in distance from the tag end portion to the first hole, or the hole is masked with a label at the edge portion. Therefore, this detection method will cause a paper end error.

8.10 RIBBON END

The ribbon sensor on the unwinder side detects a ribbon end error. When the tag and label are fed, but the ribbon on the unwinder side has not been rotating for 15mm (49.2ft) or more, the ribbon sensor will detect the ribbon end error.

8.11 RIBBON NEAR END

The ribbon sensor on the unwinder side detects a ribbon near end error. When the ribbon remaining is about 15m (49.2ft) or less, the ribbon near end error occurs.

Note that the ribbon remaining (15m, 49.2ft) is based on the desktop calculation; therefore, the occurrence of ribbon near end timing may vary depending on the sensor reading conditions.

8.12 MEDIA SIZE CHECK

This function is to check to see if the media type and size set in the printer match the values specified by the Online Data (ESC A1) command. Go to the ADVANCED MODE using the operation panel to ENABLE or DISABLE the CHECK PITCH SIZE function. Refer to **Section 3.9 Advanced Mode** for more details.



When the CHECK PITCH SIZE is enabled, the media type and size of A1 command contained in the online data will be compared to the values specified in the printer. If the difference is not within +/-2.5mm (0.1") or these specified values are not equal, MEDIA ERROR message will appear.

* The media size specified by A1 command will be shown in "L000-W000".

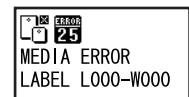

Notes:

- If the A1 command is not included in the online data, the media size will not be checked.
- For more details on the A1 command, refer to the Command Specifications.

8.13 PERFORATED LINE

Some media have perforated line between or at the center of tags so as to fold or tear by hand. The printer determines the print and cut positions in accordance with the media size detected by the sensor (transmissive or reflective). However, a sensor malfunction may occur because of a perforated line. To prevent the sensor malfunction, the printer distinguishes between a mark (a hole of 2.6mm, 0.1", approx. 20 dots), I-mark (3mm, 0.12", approx. 24 dots) and a perforated line (0.5mm, 0.02", approx. 4 dots).

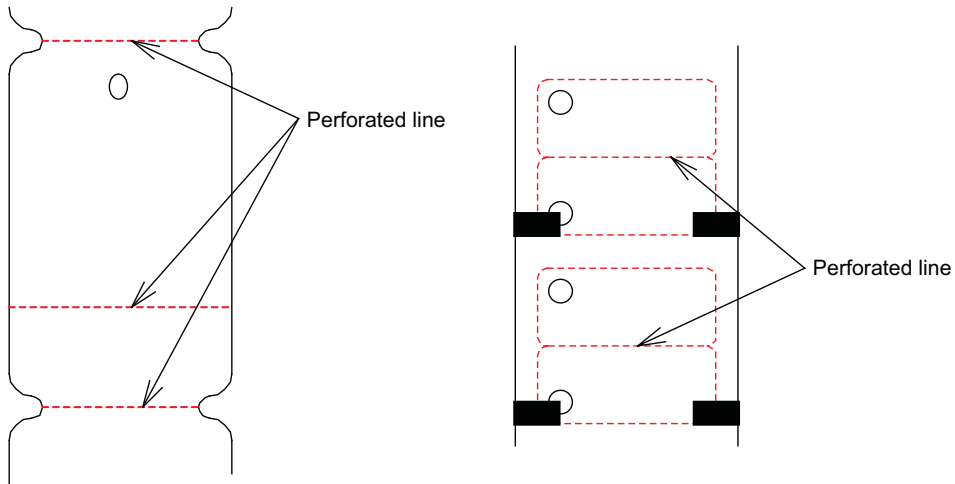

8.14 INFORMATION ON MEDIA WHEN USING CUTTER

8.14.1 Cutting of Labels

The correct cutting position is at the label gap. Cutting onto the label must be avoided because the label adhesive that accumulates on the blade will affect cutter sharpness.

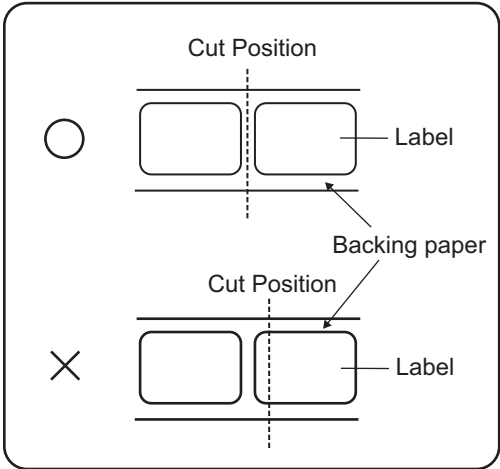

8.14.2 Cutting Media with Perforation

As for media with perforation, **cutting on or in front of the perforated lines is prohibited**. Cutting in those locations could cause the media to jam and the printer to malfunction. The perforated line +1 mm (+0.04") is the cut prohibited zone.

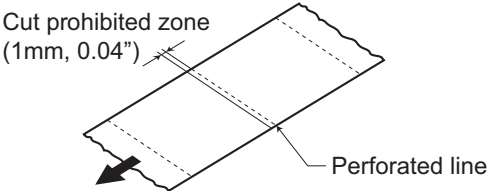

8.14.3 Cutter replacement

Over time, the cutter loses its cutting ability and begins to show signs of wear. Replace the cutter unit when the blade becomes blunt and cut edges are rough. (Please contact an authorised SATO Representative for replacement.)

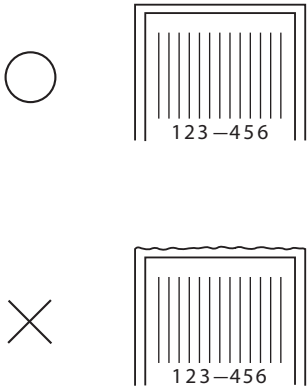

This page is intentionally left blank